

# Installations for Class C Lids

Tankmasta Toroid

Foot Traffic Only

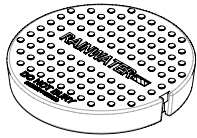

Lid Standard Lockable - WA1511

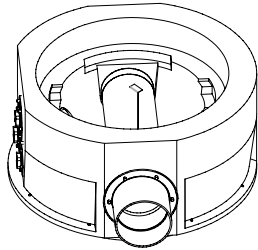

Barrel Filter Assembly Standard - TA1970

Example of installation using reinforced concrete

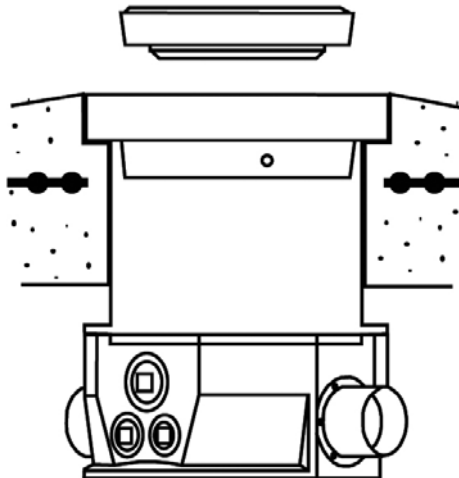

Heavy Duty

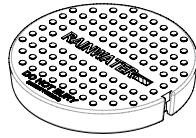

Lid Foam Filled Class C (Heavy Duty) Lockable - WA1512

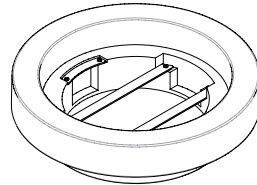

Collar Foam Filled Class C - TA1962

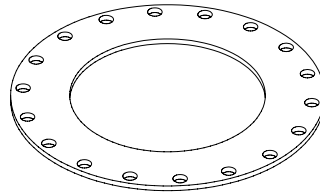

Laser Cut 12mm Mild Seal Ring - 2IHW0018

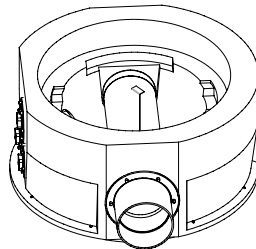

Barrel Filter Assembly (Heavy Duty) - TA1971

Heavy Duty

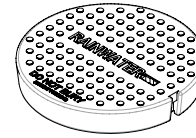

Lid Foam Filled Class C (Heavy Duty) Lockable - WA1512

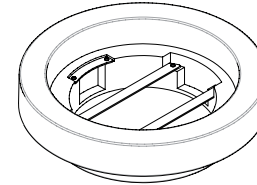

Collar Foam Filled Class C - TA1962

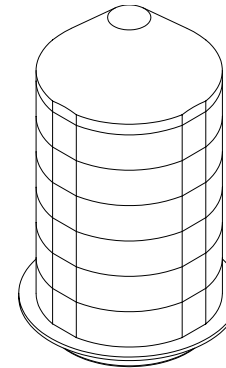

Cone Riser - TA2022

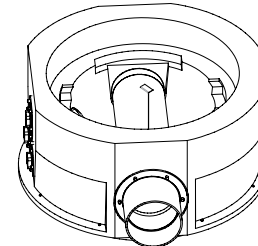

Barrel Filter Assembly Standard - TA1970

Accessories for Tankmasta Toroid Underground Water Tanks

Viscount Rotational Mouldings P/L  
81 Frankston Gardens Drive,  
Carrum Downs, Victoria, 3201  
Australia

T: (03) 8770 3200  
F: (03) 8770 3203

Sales Enquires:  
1300 366 685

E: sales@tankmasta.com.au  
W: www.tankmasta.com.au  
W: www.viscountroto.com.au  
W: www.viscount.com.au  
ABN: 19067462337

