

The background of the cover is a photograph of a rural landscape at sunset. The sun is low on the horizon, casting a warm, golden glow over the scene. In the foreground, there is a field of tall, green grasses with golden seed heads. In the middle ground, there is a wooden fence and a line of trees. To the right, a structure with a blue corrugated metal roof is visible. The sky is filled with soft, white clouds.

# Product Guide 2021 - 2022

Version 4.1

# Why Choose Polymaster?

The Polymaster difference; Top grade materials, products that are trialed and tested at every point during the design and manufacturing process, backed up with global quality and process certifications. – This is just the starting point of our promise of quality.



## Messaging Service

Know where your tank is and when to expect its delivery



## Custom Tank Builder

Industry leading technology to put you in control of your tank building journey



## Delivery

Large fleet, fast turn around times & free to many sites. See Delivery & Installation for full details - page 68



## Quality Assurance

Polymaster only produces quality products and service, certifying us for the International Standard ISO9001 for quality management



## Reliability

Our drivers take pride in getting our tanks exactly where you want them, when you need them



## Sourcing Locally

Australian owned & operated since 1994



## Find your closest store

Use our online store locator to find your nearest Polymaster retailer.



# CREATE YOUR PERFECT MATCH

## BUILD YOUR OWN TANK

Customise your water tank to suit your style and needs with our easy to use 3D Tank Builder.

Rotate your tank to see it from any angle, position your fittings, change the colours, and add on accessories.

See your selections change in real time.



Imagine taking control and building your own personal water tank!

Well... we're putting you in the driver's seat, so you control the build of your next tank. We have made it easy for you with our innovative and intuitive 3D modelling software. You can now quickly get 'up close & personal' with your tank online. Through our specialised software, you can now see your tank, look at it from every angle,

change its colours, position all your fittings and even add-on critical accessories that will keep your water fresh and clean.

And, when you've created your masterpiece you can download the exact specifications of your tank including a colour image of it and its cost. How cool is that? It's so easy!



It's online, and it's FREE at [polymaster.com.au](http://polymaster.com.au)



## Tanks

---

Premium Round Rainwater Tanks	10
Polychoice Round Rainwater Tanks	12
Builders Tank & Pump Packages	13
Premium Slimline Tanks & Pump Options	14
Polychoice Slimline Tanks & Pump Options	16
Underground Tanks	18
Septic Tanks	19
Pipeline Tanks	20
Molasses Tanks	21
Fertiliser & Fertigation	22
Aquaculture	23
Tanks Accessories	23
Pumps	26



# Agriculture

---

## **Stock Troughs & Tanks** **28**

Round Water Troughs	29
Stock Water Tank & Troughs	30
Long Water Troughs	31
Polychoice Troughs	33
Feed Troughs	34
Footrot Baths	35
Trough Spares	36

---

## **Feeders & Drinkers** **37**

Grain Feeders & Accessories	37
Calf Milk Feeders	38
Lamb Milk Feeders	39
Mobile Gravity Milk Feeders	40
Fence & Stable Drinkers	41
Teats & Accessories	42

---

## **Farm Storage Equipment** **43**

Feed Storage Bins	43
Buckets & Scoops	43
Dog Houses	44
Tractor Roofs	44
Food Grade Produce Liners & Bins	45
Bulk Storage	46
Silomaster	47
Silomaster Large Capacity	48
Vehicle Storage	49



# Agriculture

---

<b>Diesel Tanks &amp; Ute Packs</b>	<b>50</b>
Diesel Ute Packs	50
Diesel Transfer Tanks	51
Trailer Packages	52
Diesel Single Skin Smooth Wall Tanks	53
Diesel Self Bunded Tanks	54
Diesel Dispensing Units	56
Diesel Pumps & Accessories	57
Smart Diesel Dispensing	58
<hr/>	
<b>AdBlue® Tanks &amp; Ute Packs</b>	<b>60</b>
AdBlue® Storage	60
<hr/>	
<b>Fire Fighting &amp; Water Cartage</b>	<b>61</b>
Water Cartage	61
Compact Fire Fighting Packages	62
Skid Mounted Packages	63
Trailer Packages	64
Water Cartage & Fire Fighting Pumps	65
<hr/>	
<b>Safety &amp; Spill Containment</b>	<b>66</b>
<hr/>	
<b>Order Form</b>	<b>67</b>
<hr/>	
<b>Delivery &amp; Installation</b>	<b>68</b>
<hr/>	
<b>Index</b>	<b>69</b>

# Tank Categories

Browse our Tank solutions

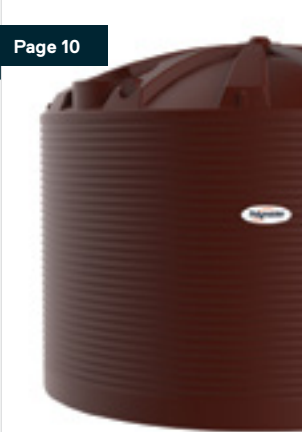

Page 10

Premium Round Rainwater Tanks



Page 12

Polychoice Round Rainwater Tanks

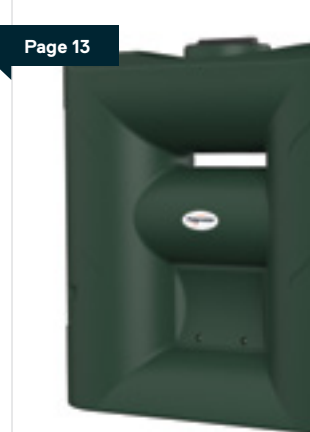

Page 13

Builders Tank & Pump Packages



Page 14

Premium Slimline Tanks & Pump Options



Page 18

Underground Tanks



Page 19

Septic Tanks



Page 20

Pipeline Tanks



Page 21

Molasses Tanks



Page 22

Fertiliser & Fertigation



Page 23

Aquaculture

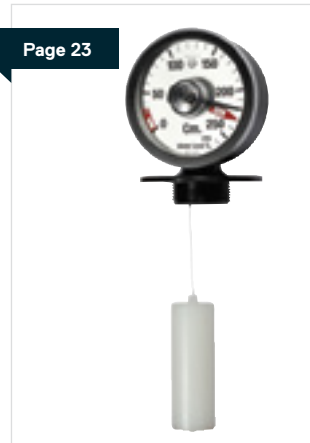

Page 23

Tank Accessories



Page 26

Pumps

# Why Buy Polymaster Rainwater Tanks



## Product Certification

Built to the Rainwater tank Standard AS/NZS 4766:2006 for peace of mind. Licence no. BMP657671 & BMP650824



## Fittings Standard

Rainwater Tanks come standard with fittings. Ask us what fittings come with the tank model you are interested in



## UV+ Double Strength

Our exclusive UV+ double strength resin gives the best protection against Australia's harsh sun



## One Piece Tank Construction

With no joins or seams, our new generation roof design eliminates the need for an internal support pole



## Food Grade

Our tanks are made from food-grade polyethylene and certified to AS/NZS4020, the Australian Standard for drinking water



## BPA Free

For your peace of mind



## Quality Assurance

Polymaster only produces quality products and service, certifying us for the international standard for quality management ISO9001



## Made in Australia

Family-owned and operated in Australia since 1994



## Extra Thick Walls

Each Polymaster tank undergoes ultrasonic thickness testing and impact testing to ensure material is correct thickness



## Tank Builder

Customise your water tank to suit your style and needs with our easy to use 3D Tank Builder





# Tank Colours

## The Standard Range

With so many choices of Colorbond® matched hues, we've made it easy to perfectly blend your new tank with your new home or surroundings. Our Standard Range takes the guesswork out of matching your tank colour with your exterior walls, guttering or roofing. No wonder this range is an Australian favourite.



## The Optional Range

If you're looking for even more colour choices, you'll find other exciting Colorbond® shades in our Optional Range. With a little extra imagination you can create a striking visual look in any outdoor space by choosing either a contrasting or complementary colour match.

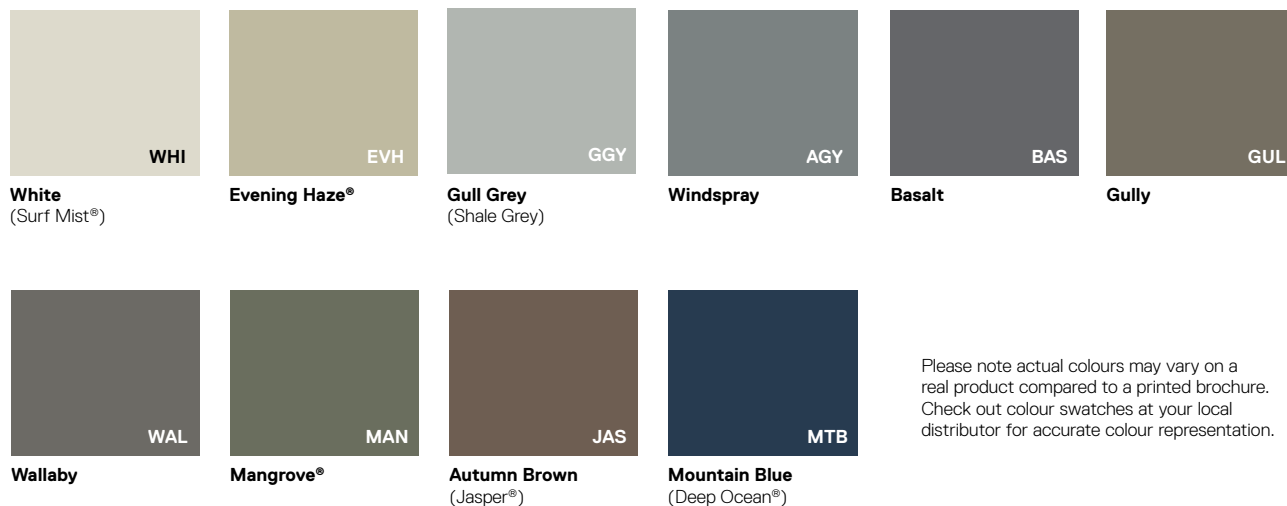

Contact us to discuss your colour project on **1800 062 064**

Colours are shown for illustrative purposes only and may vary. Polymaster will not be held liable for incorrect colour impressions. Request your Polymaster colour sample to view colours. \*COLORBOND® and colour names are registered trademarks of Blue Scope Steel Ltd.™ Polymaster tank colours represented match COLORBOND® steel colours. As we process our own resin we are able to offer a vast range of custom colours, available at an additional cost.

# Rainwater Tanks

## Premium Round Water Tanks



CODE	PROFILE	CAPACITY (Litres)	DIAMETER	OVERALL HEIGHT	INLET HEIGHT
RWT200	Corrugated	200	600	900	900
RWT600	Corrugated	600	1000	950	950
RWT1000	Corrugated	1,000	1000	1500	1500
RWT1600	Corrugated	1,600	1250	1610	1500
RWT2270T*	Corrugated	2,270	1300	2000	1920
RWT2270LP*	Corrugated	2,270	1700	1310	1200
RWT3300	Corrugated	3,300	1520	2100	2000
RWT4500T*	Corrugated	4,500	1700	2200	2100
RWT4500LP*	Corrugated	4,500	2150	1580	1380
RWT5000	Corrugated	5,000	1950	2170	1960
RWT7100	Corrugated	7,100	2150	2300	2120
RWT9000	Corrugated	9,000	2500	2260	2050
RWT13600	Corrugated	13,600	3100	2450	2100
RWT22500	Corrugated	22,500	3560	2800	2470
RWT31700	Corrugated	31,700	4100	3040	2610
RWT50KL	Smooth	50,000	4600	3440	3290

\*T = Tall

\*LP = Low Profile



CODE	STRAINER (Position)	STRAINER (Size)	OVERFLOW (Alternative)	OUTLET* (Std Position)	OUTLET SIZE	UPGRADE BALL VALVE & OUTLET	MANHOLE COVER & STRAINER
RWT200	Centre	200	12	6	25	40 - <b>BV1.5A</b> 50 - <b>BV2A</b>	Manhole - <b>MHC6</b> Strainer - <b>S2</b>
RWT600	Centre	200	12	6	25	40 - <b>BV1.5A</b> 50 - <b>BV2A</b>	Manhole - <b>MHC6</b> Strainer - <b>S2</b>
RWT1000	Centre	200	12	6	25	40 - <b>BV1.5A</b> 50 - <b>BV2A</b>	Manhole - <b>MHC6</b> Strainer - <b>S2</b>
RWT1600	12	300	11/4	6	25	40 - <b>BV1.5A</b> 50 - <b>BV2A</b>	Manhole - <b>MHC5</b> Strainer - <b>S3</b>
RWT2270T	12	300	11/5	6	25	40 - <b>BV1.5A</b> 50 - <b>BV2A</b>	Manhole - <b>MHC5</b> Strainer - <b>S3</b>
RWT2270LP	12	400	11/4	6	25	40 - <b>BV1.5A</b> 50 - <b>BV2A</b>	Manhole - <b>MHC3/MHC4</b> Strainer - <b>S4</b>
RWT3300	12	300	11/4	6	25	40 - <b>BV1.5A</b> 50 - <b>BV2A</b>	Manhole - <b>MHC5</b> Strainer - <b>S3</b>
RWT4500T	12	400	11/4	6	25	40 - <b>BV1.5A</b> 50 - <b>BV2A</b> 80 - <b>BV3A</b>	Manhole - <b>MHC3/MHC4</b> Strainer - <b>S4</b>
RWT4500LP	12	400	11/3/7	6	25	40 - <b>BV1.5A</b> 50 - <b>BV2A</b> 80 - <b>BV3A</b>	Manhole - <b>MHC3/MHC4</b> Strainer - <b>S4</b>
RWT5000	12	400	11/3/7	6	25	40 - <b>BV1.5A</b> 50 - <b>BV2A</b> 80 - <b>BV3A</b>	Manhole - <b>MHC3/MHC4</b> Strainer - <b>S4</b>
RWT7100	12	400	11/3/7	6	40	50 - <b>BV2A</b> 80 - <b>BV3A</b>	Manhole - <b>MHC3/MHC4</b> Strainer - <b>S4</b>
RWT9000	12	400	11.30/2.30/ 5.30/8.30	6	40	50 - <b>BV2A</b> 80 - <b>BV3A</b>	Manhole - <b>MHC3/MHC4</b> Strainer - <b>S4</b>
RWT13600	12	400	11/2/5/8	4	40	50 - <b>BV2A</b> 80 - <b>BV3A</b> 100 - <b>BV4A</b>	Manhole - <b>MHC3/MHC4</b> Strainer - <b>S4</b>
RWT22500	12	400	11.30/2.30/ 5.30/8.30	4	40	50 - <b>BV2A</b> 80 - <b>BV3A</b> 100 - <b>BV4A</b>	Manhole - <b>MHC3/MHC4</b> Strainer - <b>S4</b>
RWT31700	12	400	11.30/2.30/ 5.30/8.30	4	40	50 - <b>BV2A</b> 80 - <b>BV3A</b> 100 - <b>BV4A</b>	Manhole - <b>MHC3/MHC4</b> Strainer - <b>S4</b>
RWT50KL	12/6	500	2/4/6/8/10/12	4	40	50 - <b>BV2A</b> 80 - <b>BV3A</b> 100 - <b>BV4A</b>	Manhole - <b>MHCA</b> Strainer - <b>S5</b>

## DIMENSIONS

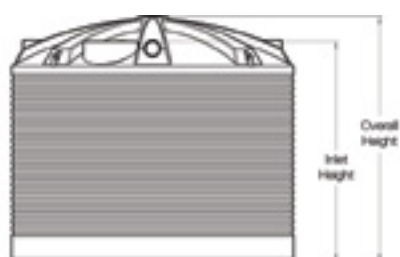

## Fit Out Clock



Refer to table for strainer, overflow and outlet positions available for each tank size.

## KEY FEATURES

- Self supporting roof means no support poles are necessary
- One piece construction means no joins or seams
- Solid brass threaded outlet & ball valve as standard
- \*Outlet location can be moved from standard based on positions on the Fit Out Clock
- Upgraded outlet and ball valves are additional cost
- Replacement manhole covers and strainers available
- Available in 22 Colorbond Colours
- 90mm overflow

Strainer



Outlet &amp; Ball Valve



Overflow



**CREATE YOUR  
PERFECT MATCH**  
BUILD YOUR OWN TANK



You can change location of the outlet and overflow with our new 3D Tank Builder

# Rainwater Tanks

## Polychoice Round Water Tanks



CODE	PROFILE	CAPACITY (Litres)	DIAMETER	OVERALL HEIGHT	INLET HEIGHT
PCR2000	Smooth	2,000	1175	2255	2185
PCR4000	Smooth	4,000	1600	2200	2150
PCR5000	Smooth	5,000	1800	2200	2120
PCR7000	Smooth	7,000	2200	2200	2020
PCR10000	Smooth	10,000	2480	2350	2170
PCR13500	Smooth	13,500	2830	2630	2470
PCR22500	Smooth	22,500	3573	2879	2559
PCR27000	Smooth	27,000	3573	3339	3019

CODE	STRAINER (Position)	STRAINER (Size)	OVERFLOW (Alternative)	*OUTLET (Std Position)	OUTLET SIZE	UPGRADE OUTLET	MANHOLE COVER & STRAINER
PCR2000	12	300	10.30, 1.30, 4.30, 7.30	6	25	40 - LHO1.5 50 - LHO2	Manhole - MHC6 Strainer - S3
PCR4000	12	400	10.30, 1.30, 4.30, 7.30	6	25	40 - LHO1.5 50 - LHO2	Manhole - MHC7 Strainer - S4
PCR5000	12	400	10.30, 1.30, 4.30, 7.30	6	25	40 - LHO1.5 50 - LHO2	Manhole - MHC7 Strainer - S4
PCR7000	12	400	10.30, 1.30, 4.30, 7.30	6	25	40 - LHO1.5 50 - LHO2	Manhole - MHC7 Strainer - S4
PCR10000	12	400	10.30, 1.30, 4.30, 7.30	6	40	50 - LHO2 80 - LHO3 100 - LHO4	Manhole - MHCA Strainer - S4
PCR13500	12	400	10.30, 1.30, 4.30, 7.30	6	40	50 - LHO2 80 - LHO3 100 - LHO4	Manhole - MHCA Strainer - S4
PCR22500	12	500	10.30, 1.30, 4.30, 7.30	6	40	50 - LHO2 80 - LHO3 100 - LHO4	Manhole - MHCA Strainer - S5
PCR27000	12	500	10.30, 1.30, 4.30, 7.30	6	40	50 - LHO2 80 - LHO3 100 - LHO4	Manhole - MHCA Strainer - S5

### DIMENSIONS

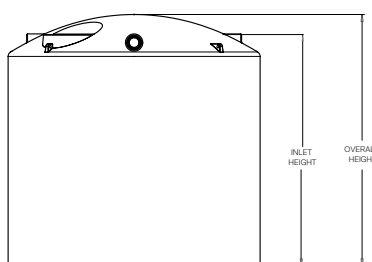

### Fit Out Clock

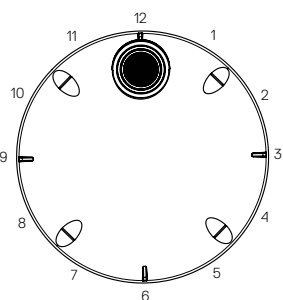

### KEY FEATURES

- Self supporting roof means no support poles are necessary
- One piece construction means no joins or seams
- Solid brass threaded outlet as standard
- \*Outlet location can be moved from standard based on positions on the Fit Out Clock
- Upgraded outlet and ball valves are additional cost
- Replacement manhole covers and strainers available
- Available in 22 Standard Colorbond colours

Refer to table for strainer, overflow and outlet positions available for each tank size.

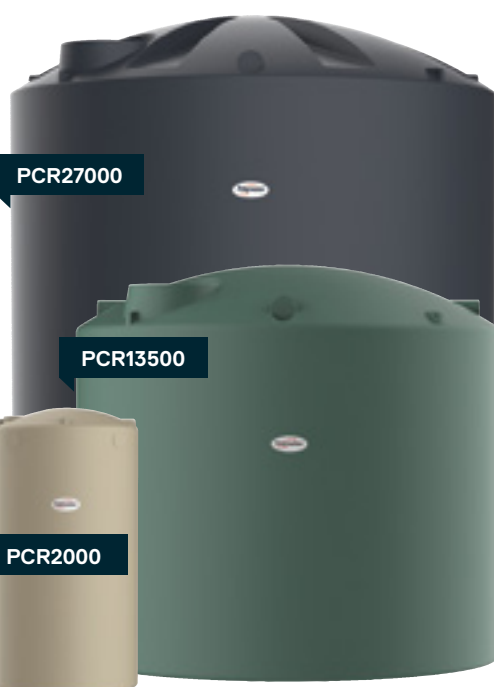

# Slimline Tanks

## Builders Tank & Pump Packages



CODE	PUMP CAPABILITY	CAPACITY (Litres)	PUMP CODE	LENGTH	WIDTH	HEIGHT	INLET HEIGHT	OUTLET (Position)	OUTLET SIZE
BSLT2020H4	Single Storey Dwellings	2,020	MHR20-370	2105	735	2010	2010	6&12	25
BSLT2020H5	Double Storey Dwellings	2,020	MHR20-550	2105	735	2010	2010	6&12	25

## Accessories

CODE	DESCRIPTION
BSLT2020PC	Pump Cover for BLST2020
MHC8	Inspection Cover 400mm
S4	Inlet Strainer 400mm

## PUMP INFORMATION

Automatic hydraulic Rain/Mains water changeover device designed for pressure pump supply systems in harvesting rainwater for the toilet, laundry and household applications with automatic mains backup.

\*Refer to Page 26 & 27 for Pump Details.

## KEY FEATURES

- 10 minute quick install - pump built in, just hook it up
- Moulded handgrips for easy lifting
- 2 x 90mm overflows + 1 cap
- 2 x outlets + 1 cap
- Flexhose 20mm x 600mm Female thread
- Hoses for connection at approximately 400mm high
- Available in 22 Standard Colorbond colours
- Fits through a standard doorway

## DIMENSIONS

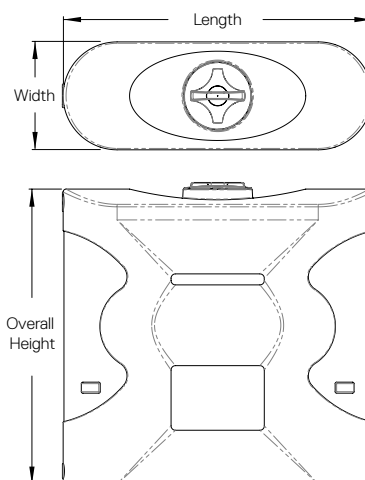

**CREATE YOUR PERFECT MATCH**

**BUILD YOUR OWN TANK**

You can change location of the outlet and overflow with our new 3D Tank Builder

# Premium Slimline Tanks & Pump Options



## Tank Only

CODE	CAPACITY (Litres)	LENGTH	WIDTH	INLET HEIGHT
SLST600	600	1220	580	1265
SLST1050	1,050	1460	690	1515
SLST2000	2,000	2370	600	2010
SLST3000	3,000	2570	790	2050
SLST5000	5,000	3290	1020	2010

CODE	STRAINER (Position)	STRAINER (Size)	OVERFLOW POSITION	OUTLET POSITION	OUTLET SIZE	BALL VALVE & OUTLET UPGRADE	MANHOLE COVER & STRAINER
SLST600	6 Std/12 Alt	300	<b>12 Std/6 Alt</b>	<b>6 Std/12 Alt</b>	25	40mm - <b>BV1.5A</b>	Manhole Cover - <b>MHC9</b> Strainer - <b>S3</b>
SLST1050	6 Std/12 Alt	400	<b>12 Std/6 Alt</b>	<b>6 Std/12 Alt</b>	25	40mm - <b>BV1.5A</b>	Manhole Cover - <b>MHC8</b> Strainer - <b>S4</b>
SLST2000	6 Std/12 Alt	400	<b>12 Std/6 Alt</b>	<b>6 Std/12 Alt</b>	25	40mm - <b>BV1.5A</b>	Manhole Cover - <b>MHC8</b> Strainer - <b>S4</b>
SLST3000	6 Std/12 Alt	400	<b>12 Std/6 Alt</b>	<b>6 Std/12 Alt</b>	25	40mm - <b>BV1.5A</b>	Manhole Cover - <b>MHC8</b> Strainer - <b>S4</b>
SLST5000	6 Std/12 Alt	400	<b>12 Std/6 Alt</b>	<b>6 Std/12 Alt</b>	25	40mm - <b>BV1.5A</b> 50mm - <b>BV2A</b>	Manhole Cover - <b>MHC8</b> Strainer - <b>S4</b>

## Tank & Submersible Pump System

CODE	CAPACITY (Litres)	LENGTH	WIDTH	INLET HEIGHT	PUMP CODE
SLST1050AP	1,050	1460	690	1515	HHR-370S-PC
SLST2000AP	2,000	2370	600	2010	HHR-370S-PC
SLST3000AP	3,000	2570	790	2050	HHR-370S-PC
SLST5000AP	5,000	3290	1020	2010	HHR-370S-PC

CODE	STRAINER (Position)	STRAINER (Size)	OVERFLOW POSITION	OUTLET POSITION	OUTLET SIZE	BALL VALVE & OUTLET UPGRADE	MANHOLE COVER & STRAINER
SLST1050AP	6 Std/12 Alt	400	<b>12 Std/6 Alt</b>	<b>6 Std/12 Alt</b>	25	40mm - <b>BV1.5A</b>	Manhole Cover - <b>MHC8</b> Strainer - <b>S4</b>
SLST2000AP	6 Std/12 Alt	400	<b>12 Std/6 Alt</b>	<b>6 Std/12 Alt</b>	25	40mm - <b>BV1.5A</b>	Manhole Cover - <b>MHC8</b> Strainer - <b>S4</b>
SLST3000AP	6 Std/12 Alt	400	<b>12 Std/6 Alt</b>	<b>6 Std/12 Alt</b>	25	40mm - <b>BV1.5A</b>	Manhole Cover - <b>MHC8</b> Strainer - <b>S4</b>
SLST5000AP	6 Std/12 Alt	400	<b>12 Std/6 Alt</b>	<b>6 Std/12 Alt</b>	25	40mm - <b>BV1.5A</b> 50mm - <b>BV2A</b>	Manhole Cover - <b>MHC8</b> Strainer - <b>S4</b>

**CREATE YOUR  
PERFECT MATCH**  
BUILD YOUR OWN TANK



You can change location of  
the outlet and overflow with  
our new 3D Tank Builder

## Tank & Garden Pump System

CODE	CAPACITY (Litres)	LENGTH	WIDTH	INLET HEIGHT	PUMP CODE	PUMP COVER SUPPLIED
SLST1050GPS	1,050	1460	690	1515	DHJ600	PC01
SLST2000GPS	2,000	2370	600	2010	DHJ600	PC01
SLST3000GPS	3,000	2570	790	2050	DHJ600	PC01
SLST5000GPS	5,000	3290	1020	2010	DHJ600	PC01

CODE	STRAINER (Position)	STRAINER (Size)	OVERFLOW POSITION	OUTLET POSITION	OUTLET SIZE	BALL VALVE & OUTLET UPGRADE	MANHOLE COVER & STRAINER
SLST1050GPS	6 Std/12 Alt	400	12 Std/6 Alt	6 Std/12 Alt	25	40mm - <b>BV1.5A</b>	Manhole Cover - <b>MHC8</b> Strainer - <b>S4</b>
SLST2000GPS	6 Std/12 Alt	400	12 Std/6 Alt	6 Std/12 Alt	25	40mm - <b>BV1.5A</b>	Manhole Cover - <b>MHC8</b> Strainer - <b>S4</b>
SLST3000GPS	6 Std/12 Alt	400	12 Std/6 Alt	6 Std/12 Alt	25	40mm - <b>BV1.5A</b>	Manhole Cover - <b>MHC8</b> Strainer - <b>S4</b>
SLST5000GPS	6 Std/12 Alt	400	12 Std/6 Alt	6 Std/12 Alt	25	40mm - <b>BV1.5</b> 50mm - <b>BV2A</b>	Manhole Cover - <b>MHC8</b> Strainer - <b>S4</b>

### DIMENSIONS

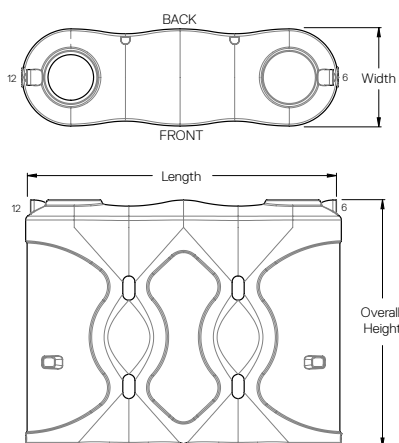

### PUMP INFORMATION

Automatic hydraulic Rain/Mains water changeover device designed for pressure pump supply systems in harvesting rainwater for the toilet, laundry and household applications with automatic mains backup.

\*Refer to pages 26 & 27 for Pump Details



### KEY FEATURES

- Space saving modern design
- Moulded handgrips for easy lifting
- 90mm overflow
- 25mm Solid Brass outlet
- Ball valve as standard
- Available in 22 Colorbond Colours



# Polychoice Slimline Tanks & Pump Options



## Tank Only

CODE	CAPACITY (Litres)	LENGTH	WIDTH	INLET HEIGHT
PCST2000	2,000	2370	600	2010
PCST3000	3,000	2570	790	2050

CODE	STRAINER (Position)	STRAINER (Size)	OVERFLOW POSITION	OUTLET POSITION	OUTLET SIZE	OUTLET UPGRADE	MANHOLE COVER & STRAINER
PCST2000	6 & 12	400	12 Std/6 Alt	6 Std/12 Alt	25	40 - LHO1.5	Manhole Cover - <b>MHC8</b> Strainer - <b>S4</b>
PCST3000	6 & 12	400	12 Std/6 Alt	6 Std/12 Alt	25	40 - LHO1.5	Manhole Cover - <b>MHC8</b> Strainer - <b>S4</b>

## Tank & Submersible Pump System

CODE	CAPACITY (Litres)	LENGTH	WIDTH	INLET HEIGHT	PUMP CODE
PCST2000AP	2,000	2370	600	2010	HHR-370S-PC
PCST3000AP	3,000	2570	790	2050	HHR-370S-PC

### PUMP INFORMATION

Automatic hydraulic Rain/Mains water changeover device designed for pressure pump supply systems in harvesting rainwater for the toilet, laundry and household applications with automatic mains backup.

\* Refer to pages 26 & 27 for Pump Details

### KEY FEATURES

- Space saving modern design
- Moulded handgrips for easy lifting
- 90mm overflow
- 25mm Solid Brass outlet as standard
- Available in 22 Standard Colorbond colours

### DIMENSIONS

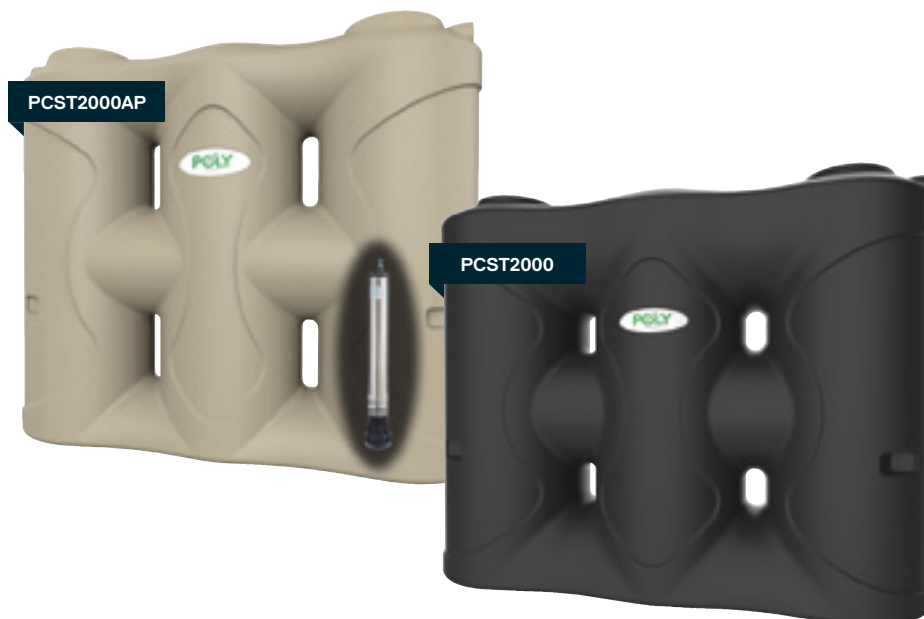
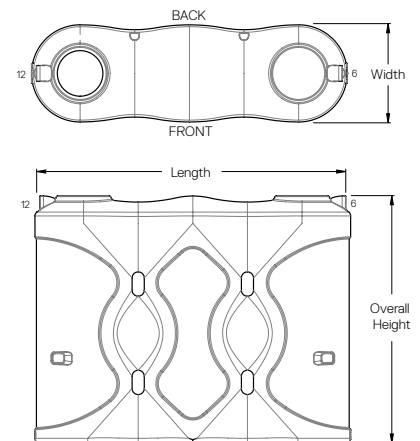



# Retention & Detention

## What are Retention - Detention tanks?

Retention and Detention tanks are often prescribed by councils and government bodies to control the release of water into the stormwater system.

All Polymaster above-ground rainwater tanks (round or slim) can be adapted to meet your retention or detention needs.

## Why is it important?

Urban drainage systems are under more and more pressure. Due to urbanisation, storm water systems handle more water as there's more rain falling on roofs and paved areas instead of naturally draining into water ways and the water table.

By installing a Polymaster Retention or Detention tank in subdivisions and urban areas, you can both protect the drainage system and comply with local council regulations.

## Controlled release outlets

Polymaster offer a wide range of specialised outlets for this purpose.

Water release is restricted by outlet size and / or orifice plate, usually specified by your local council.

## Detention function

In the event of heavy rainfall the upper portion of tank temporarily contains the water surge.

This process is known as stormwater detention and takes the pressure off municipal stormwater systems with this water being slowly released through a small outlet.

## Retention function

The lower portion of this tank functions simply to retain a sustainable supply of rainwater for household or garden use.

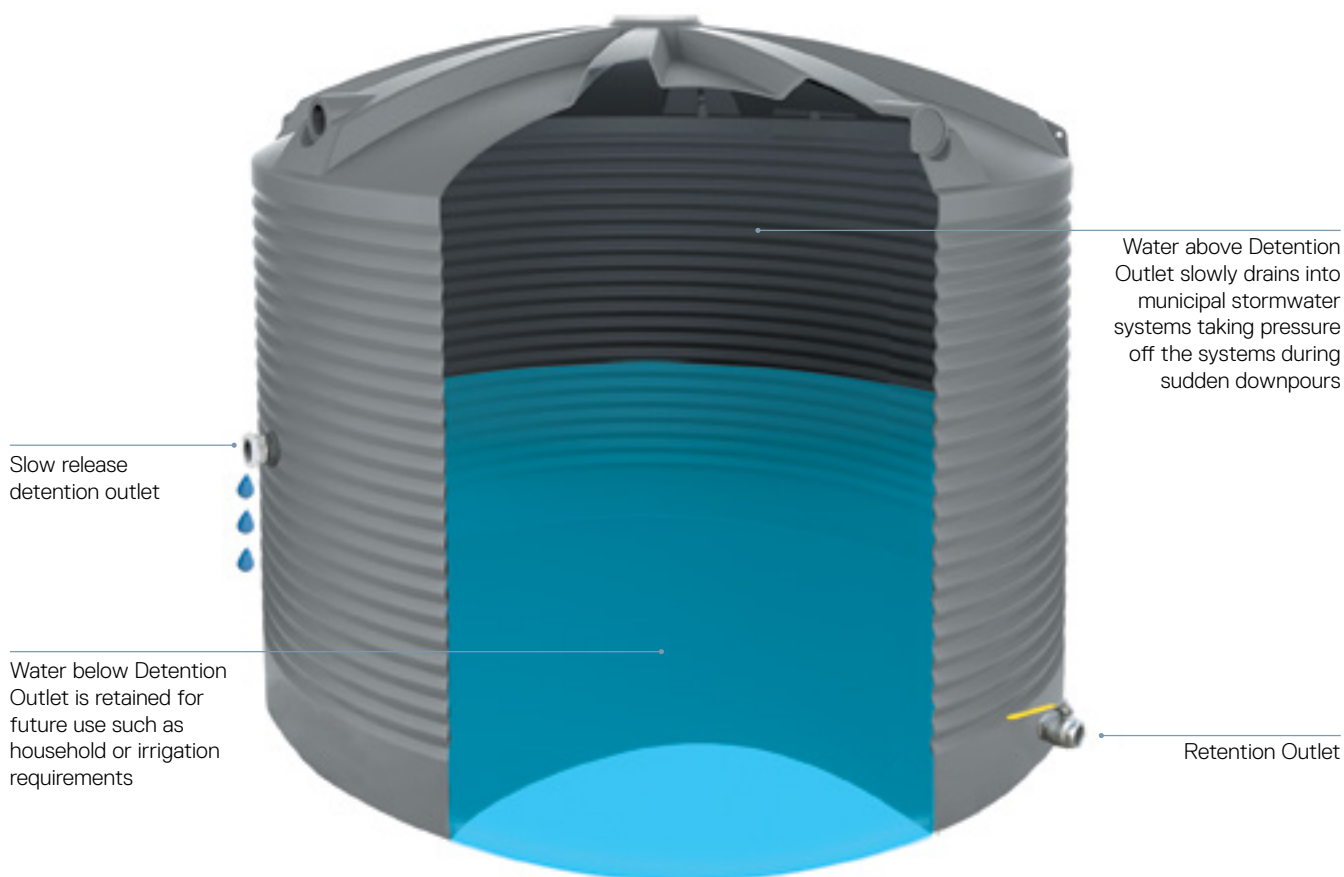
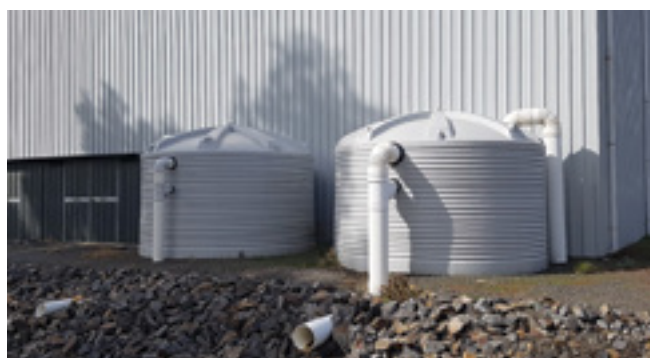

# Underground Tanks



CODE	DESCRIPTION	CAPACITY (Litres)	LENGTH	WIDTH	HEIGHT	OUTLET SIZE
URT3300B	Tank Only	3,300	2450	1640	1665	32mm BSPF
URT5000B	Tank Only	5,000	3520	1640	1665	32mm BSPF
URT3300VF	Tank with Vortex Filter	3,300	2450	1640	1665	32mm BSPF
URT5000VF	Tank with Vortex Filter	5,000	3520	1640	1665	32mm BSPF
URT3300VF/PC	Tank with Vortex Filter inc submersible pump & automatic changeover device	3,300	2450	1640	1665	32mm BSPF
URT5000VF/PC	Tank with Vortex Filter inc submersible pump & automatic changeover device	5,000	3520	1640	1665	32mm BSPF
URT3300VF/GP	Tank with Vortex Filter & garden pump with press control	3,300	2450	1640	1665	32mm BSPF
URT5000VF/GP	Tank with Vortex Filter & garden pump with press control	5,000	3520	1640	1665	32mm BSPF

## Pump Details

TYPE	VOLTAGE	POWER (kW)	HEAD	FLOW	INLET	OUTLET	WARRANTY
Submersible Pump (PC)	220-240v	0.75kW (750 watts)	36m	115LPM	20mm BSPM	20mm BSPM	2 years
Garden Pump (GP)	220-240v	0.37kW (370 watts)	36m	82LPM		25mm BSPF	2 years

## Accessories

CODE	ACCESSORIES
URRM	500mm Riser - for deeper installations
UMFO	Multifunctional backflow prevention valve
URTL	Lid to suit Underground Tanks

## VORTEX FINE FILTER

Self cleaning filter removes sediment and debris, providing you with clean water for storage. Wall mounting bracket available.

## Example Setup Underground Tank with Vortex Filter and Submersible Pump options



## KEY FEATURES

- Child-proof lid secured with tamper proof screws
- Self-anchoring
- Low profile design - minimal excavation required
- Uni Seals supplied
- Tank to tank connection point

## DIMENSIONS

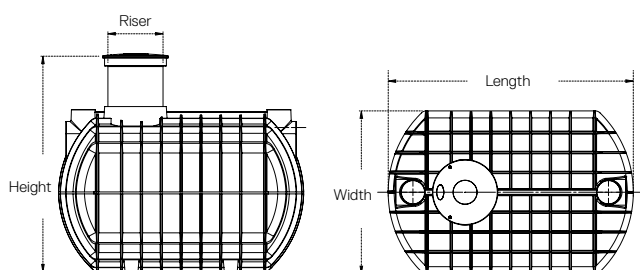

# Septic Tanks



CODE	DESCRIPTION	CAPACITY (Litres)	LENGTH	WIDTH	HEIGHT	INLET SIZE	OUTLET SIZE	NO. OF PERSONS
ST3100	Septic Tank	3,100	2450	1640	1665	100	100	1-5 people
ST4550	Septic Tank	4,550	3520	1640	1665	100	100	6-10 people

## Accessories

CODE	ACCESSORIES
URRM	500mm Riser - for deeper installations
STLIDHGR	Lid to suit Septic Tank

KEY FEATURES
<ul style="list-style-type: none"> <li>Self anchoring - does not require concrete</li> <li>Fittings and baffle pre-installed</li> <li>Certified for NSW, VIC, SA</li> <li>10 minute hook up</li> <li>Low profile design - minimal excavation required</li> <li>One piece construction</li> <li>100mm inlet and outlet preinstalled</li> <li>Heavy duty lid tested to 500kg loading</li> <li>500mm riser extension available</li> </ul>

## DIMENSIONS

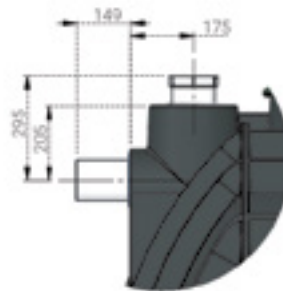
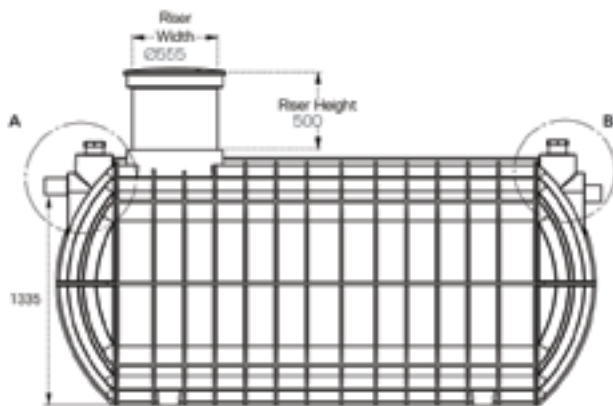

DETAIL A (INLET)

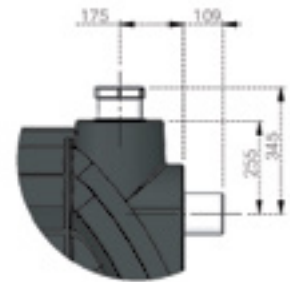

DETAIL B (OUTLET)



# Pipeline Tanks



CODE	CAPACITY (Litres)	DIAMETER	INLET HEIGHT	OVERALL HEIGHT	OVERFLOW SIZE	INLET / OUTLET SIZE
PLT9000	9,000	2500	2050	2260	90	32+50
PLT13600	13,600	3100	2100	2450	90	32+50
PLT22500	22,500	3560	2470	2800	90	32+50
PLT31700	31,700	4100	2610	3040	90	32+50
PLT50KL	50,000	4600	3290	3440	90	32+50

## KEY FEATURES

- Inspection cover
- 90mm overflow/breather & screen
- AFV2LB 32mm brass fitting and 25mm poly float
- 50mm outlet and ball valve

## STANDARD FITTINGS AND LOCATIONS

12:00	Inspection Cover
2:30	Breather /Overflow
4:00	50mm Brass Outlet & Ball Valve
11:30	Fitting & Float Valve

\* Pipeline fittings pg 25.

## DIMENSIONS

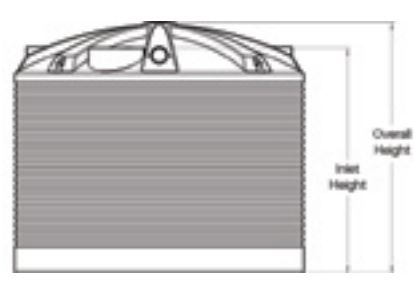

Fit Out Clock

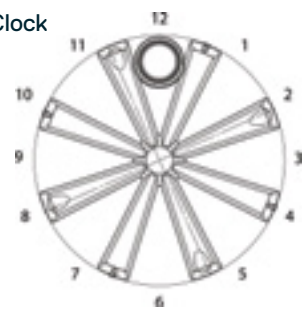

Refer to table for strainer, overflow and outlet positions available for each tank size.

**Made to Order -**  
Call us today to discuss your fit out and fitting options



Optional internal pipework fit out available

# Molasses Storage Tanks



CODE	PROFILE	CAPACITY (Litres)	DIAMETER	OVERALL HEIGHT	INLET HEIGHT	OVERFLOW SIZE	OUTLET SIZE
MOL13600	Corrugated	13,600	3100	2450	2100	90	80
MOL22500	Corrugated	22,500	3560	2800	2470	90	80
MOL31700	Corrugated	31,700	4100	3040	2610	90	80
MOL50KL	Smooth	50,000	4600	3440	3290	90	80

## KEY FEATURES

- Heavy duty wall thickness
- Ideal for liquids up to 1.4SG
- Standard with 80mm brass outlet and inspection cover
- Fitted with overflow as breather and screen

## DIMENSIONS



### Fit Out Clock

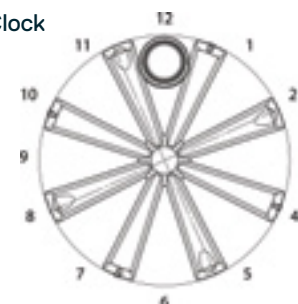

Refer to table for strainer, overflow and outlet positions available for each tank size.



# Liquid Fertiliser Storage

## Liquid Fertiliser Storage Tanks



CODE	CAPACITY (Litres)	DIAMETER	INLET HEIGHT	OVERALL HEIGHT	OVERFLOW SIZE	TOP FILL KIT
LFT9000	9,000	2500	2050	2260	90	LFTK
LFT13600	13,600	3100	2100	2450	90	LFTK
LFT22500	22,500	3560	2470	2800	90	LFTK
LFT31700	31,700	4100	2610	3040	90	LFTK
LFT50KL	50,000	4600	3290	3440	90	LFTK

### KEY FEATURES

- Heavy duty construction to suit liquids up to 1.4SG
- Level indicator as standard
- Inspection cover
- Standard with 50mm Stainless Steel Outlet, Ball Valve and Camlock

### DIMENSIONS

#### Fit Out Clock

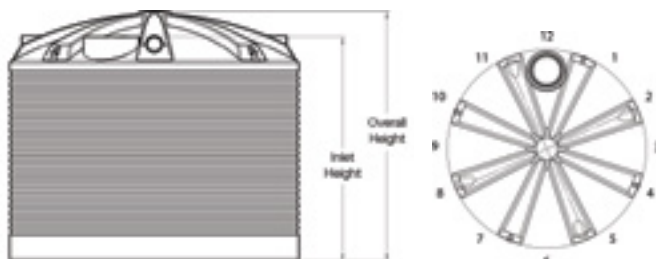

Refer to table for strainer, overflow and outlet positions available for each tank size.



LFT22500

\*Pole not included

### STANDARD FITTINGS AND LOCATIONS

12:00	Inspection Cover
12:30	2" Stainless Steel Outlet ( <b>LH02SS</b> )
12:30	2" Stainless Steel Camlock (bottom fill connection)
12:30	2" Stainless Steel Ball Valve
1:30	Liquidator - True Level Indicator ( <b>LQ01</b> )
2:30	Breather / Overflow

### 3" STAINLESS STEEL UPGRADE OPTION

- 3" Outlet (**LH03SS**)
- 3" Camlock (**SC80-F**)
- 3" Ball Valve (**SSBV3**)

## Fertigation Tank + Base & Venturi Fitout



CODE	CAPACITY	DIMENSIONS	LID
FT2000B+V	2,000 ltr	2000 DIA x 1000 H	FTL2000
FT5000B+V	5,000 ltr	2850 DIA x 1180 H	
FT9000B+V	9,000 ltr	3500 DIA x 1280 H	
FTL2000	Lid to suit 2,000 ltr Fertigation Tank	2180 DIA	



\*Pump not included

## Recommended Pump for Venturi Setup

CODE	DESCRIPTION	ENGINE/ PUMP	POWER (HP)	HEAD	FLOW (LPM)	INLET	OUTLET	WARRANTY
HTP750VR	Chemical Transfer Pump Honda 6.5HP	Honda/Onga	6.5	40m	750	50mm NPT	50mm NPT	2 years

### KEY FEATURES

- No internal pipework within tank to damage fish or get in the way
- Self draining tank with integrated moulded sump connects to PVC 65mm, 100mm for 5000 & 9000 Ltr
- PVC pipe not included
- 10 degree sloping base
- 50mm Camlock with base & venturi set up
- Pumps to suit venturi system available

### DIAGRAM

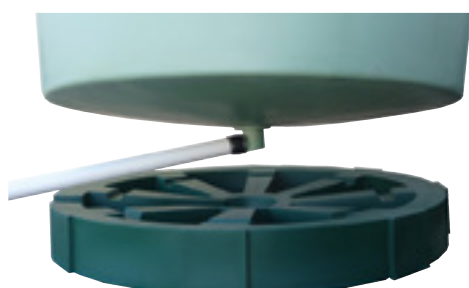
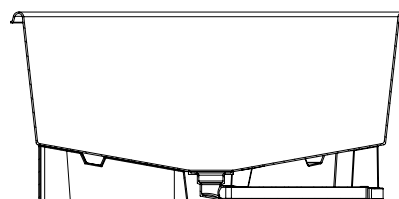

# Aquaculture

## Aquaculture Tanks

CODE	DESCRIPTION	DIMENSIONS	POLY RISER	FLOOR SLOPE ANGLE	WATER CONTROLLER KIT
FT200	200 ltr Flat Bottom Tank	800 DIA x 560 H			
FT500B	500 ltr Tank + Base	1000 DIA x 1000 H	APRS	80mm	WCK01
FT1000B	1,000 ltr Tank + Base	1420 DIA x 1200 H	APRS	40mm	WCK01
FT2000B	2,000 ltr Tank + Base	2000 DIA x 1000 H	APRS	150mm	WCK01
FT5000B	5,000 ltr Tank + Base	2850 DIA x 1180 H	APRS	120mm	WCK02
FT9000B	9,000 ltr Tank + Base	3500 DIA x 1280 H	APRS	100mm	WCK02
FTL2000	Lid to suit 2000L Tank	2180 DIA			

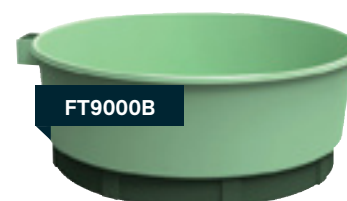

# Accessories

## Inspection Covers

CODE	DESCRIPTION
MHC1	Inspection Cover for 13,600ltr to 31,700ltr
MHC3	Water Entry Cover for Tanks with 400mm Sieve
MHC4	Inspection Cover for Tanks with 400mm Sieve
MHC5	Inspection Cover for RWT3300, RWT2270T and RWT1600 Tanks
MHC6	Inspection Cover for RWT1000, RWT600 and RWT200
MHC8	Inspection Cover for Slimline Tanks 1050, 2000, 3000 and 5000ltr
MHC9	Inspection Cover for Slimline Tanks SLST600 only
MHCA	Manhole Cover Adapter - Black

## Water Level Indicators

CODE	DESCRIPTION
CLG	Clock Level Gauge
DPK1	Dipstick
DPK1EXT	Dipstick Extension For 50KI Tank
LT01	Levetator - Water Level Indicator
LQ01	Liquidator - Suitable For Corrosive Liquids

## Other Rainwater Accessories

CODE	DESCRIPTION
LGSO	Leaf Guard - Swivel Outlet
LWD	Downpipe Water Diverter
OFF9	90mm Overflow Flanged
OFP	Plug To Fit 90mm Overflow
OS9	90mm Overflow Screen
OFF10	100mm Overflow Flanged
JOS10	100mm Ozzie Seal For Overflow
JOS1210	100mm x 125mm Ozzie Seal Reducer For WCK02
JOS65	65mm Ozzie Seal For Sump And Water Controller Of FT500B And FT9000B Tanks
PC01	Pump Cover

## Tank Stands

CODE	DESCRIPTION	DIMENSIONS (L x W x H)
TS600	Stand to Suit 600Ltr Round Tank	885 x 885 x 520
TS1000	Stand to Suit 1000Ltr Round Tank	1055 x 1055 x 520
SSTS6	Stand to Suit 600Ltr Slimline Tank	1210 x 650 x 520
SSTS10	Stand to Suit 1050Ltr Slimline Tank	1450 x 700 x 520

## Slimline Tank Accessories

CODE	DESCRIPTION
CVB20	20mm Brass check valve
STCH20	3/4" Flexible connection hose for Changeover Device - 600mm long
STCH20L	3/4" Flexible connection hose for Changeover Device - 1000mm long
RFO1	1" Plastic retro fit outlet to suit pump suction on Slimline Tank
TB2	20mm Tank Bibcock for Slimline Tanks

## Underground Tank Accessories

CODE	DESCRIPTION
JOS90	90mm Ozzie Seal For Overflow
UMFO	Multifunctional Backflow Prevention Valve For Underground Tanks
URRM	500mm Riser - For Deeper Installations
URTL	Lid To Suit Underground Tanks
R10112	Uniseal 100mm



MHC1



CLG



LGSO



TS600



SSTS10



LT01



### Vortex Self-Cleaning Fine Filters

CODE	DESCRIPTION
URVF01	Vortex Filter Suitable For Roof Areas Up To 200Sq Metres
URVF15	Vortex Filter Suitable For Roof Areas Up To 500Sq Metres
URVF30	Vortex Filter Suitable For Roof Areas Up To 3000Sq Metres
URVFR	Riser Only - For Vortex Self Cleaning Filter
URVFWM	Vortex Filter Wall Mount



### Tank Inlet Filter

CODE	DESCRIPTION
TIF3	Tank Inlet Filter 300mm including Sieve
TIF4	Tank Inlet Filter 400mm including Sieve



### Sieves / Inlet Strainers

CODE	DESCRIPTION
S2	Sieve 200mm
S3	Sieve 300mm
S4	Sieve 400mm
S5	Sieve 500mm



### Rural Fire Tank Fittings

CODE	DESCRIPTION
CFA1	65mm CFA Coupling Only (VIC)
CFA2	65mm CFA Coupling complete with 50mm (2") Outlet & Ball Valve
CFAC	Cap to suit CFA1
CFANT	65mm CFA Coupling nut and tail (VIC)
CFS1	65mm CFS Coupling Only (SA)
CFS2	65mm CFS Coupling (SA) Complete with 50mm (2") Outlet & Ball Valve
RFS	Rural Fire Service Fitting (NSW)
RFS2	RFS Coupling Complete (VIC Metro, NSW Rural)



### Fittings for Pipeline Tanks

CODE	DESCRIPTION
AFV2L	25mm (1") plastic Sleeve Valve - Long Arm
AFV2LB	25mm (1") including 1.25" M & F Brass Outlet Plastic Sleeve Valve - Long Arm
IRS32	Internal raised Suction 32mm - suit 40mm outlet
IRS40	Internal raised Suction 40mm - suit 50mm outlet
PLTIP25	Pipeline Tank Internal Pipework 25mm
PLTIP40	Pipeline Tank Internal Pipework 40mm
PT2132	32mm (1 1/4") Dual Level reservoir valve
PT2140	40mm (1 1/2") Dual Level reservoir valve
PT2150	50mm (2") Dual Level reservoir valve
WV1	25mm (1") Watermark approved Float Valve
WV2	32mm (1 1/4") Watermark approved Float Valve
WV3	40mm (1 1/2") Watermark approved Float Valve

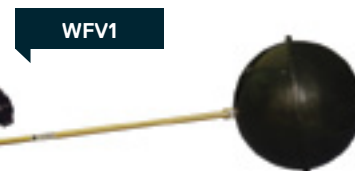

### Stainless Steel Outlets

CODE	DESCRIPTION
LHO1SS	25mm M+F SS
LHO1.25SS	32mm M+F SS
LHO1.5SS	40mm M+F SS
LHO2SS	50mm M+F SS
LHO3SS	80MM M+F SS

### Stainless Steel Ball Valves

CODE	DESCRIPTION
SSBV1	25mm SS
SSBV2	50mm SS
SSBV3	80mm SS
SC80-F	Camlock Type F 80mm BSP SS

# Water Pumps

## Household Pumps with Brass Rain/Mains Changeover Device

CODE	DESCRIPTION	WATTAGE	MAX FLOW (LPM)	POWER (kW)	INLET	OUTLET	WARRANTY
MHR20-370	Single Story Pump	370W	55	0.37	25mm BSPF	20mm BSPF	3 years
MHR20-550	Double Story Pump	550W	70	0.55	25mm BSPF	20mm BSPF	3 years

MHR20-370



MHR20-550



## Submersible Pumps

CODE	DESCRIPTION	WATTAGE	MAX FLOW (LPM)	POWER (kW)	CABLE LENGTH	OUTLET	WARRANTY
HHR-370PC	Pump & Press Control	370W	115	0.75	5m	20mm BSPM	2 years
HHR-370S-PC	Pump & Water Switch	370W	82	0.5	5m	32mm BSPF	2 years

HHR-370PC



HHR-370S-PC



## Garden Pumps with Press Control

CODE	WATTAGE	MAX FLOW (LPM)	POWER (kW)	INLET	OUTLET	WARRANTY
DHJ600	600W	45	0.6	25mm BSPF	25mm BSPM	2 years
DHJ800	800W	55	0.8	25mm BSPF	25mm BSPM	2 years
HSJ1000	1000W	85	1	25mm BSPF	25mm BSPM	3 years



## Pump Packages - Pump + Pump Cover

CODE	DESCRIPTION	WATTAGE	MAX FLOW (LPM)	POWER (kW)	INLET	OUTLET	WARRANTY	PUMP COVER (L x W x H)
PHGPS	Garden Pump with Press Control & Pump Cover	600W	45	0.6	25mm BSPF	25mm BSPM	2 years	700L x 450W x 560H mm
PH400	Household Pump With Brass Changeover Device & Pump Cover	370W	55	0.37	25mm BSPF	20mm BSPF	3 years	700L x 450W x 560H mm
PH550	Household Pump With Brass Changeover Device & Pump Cover	550W	70	0.55	25mm BSPF	20mm BSPF	3 years	700L x 450W x 560H mm

\*Dimensions are approximate



# Agriculture Categories

Browse our Agriculture Solutions

Page 28



Stock Troughs & Tanks

Page 37



Feeders & Drinkers

Page 38



Calf & Lamb Feeding

Page 43



Farm Storage Equipment

Page 50



Diesel Tanks & Ute Packs

Page 54



Diesel Self Bunded tanks

Page 60



AdBlue® Tanks & Ute Packs

Page 61



Fire Fighting & Water Cartage

Page 66



Safety & Spill Containment

# Round Water Troughs

## Master Tub Troughs



CODE	CAPACITY (Litres)	DIMENSIONS	FLOAT INLET	PRESSURE	DRAIN	DRAIN CAP	FLOAT COVER
MT2	200	970 DIA x 375H	25mm BSPM	140psi / 965 kPa	75	DC3	MTFC
MT6	600	1400 DIA x 520H	25mm BSPM	140psi / 965 kPa	75	DC3	MTFC
MT12	1,200	1765 DIA x 600H	25mm BSPM	140psi / 965 kPa	75	DC3	MTFC
MT24	2,400	2380 DIA x 650H	25mm BSPM	140psi / 965 kPa	75	DC3	MT05
MT45	4,500	3730 DIA x 650H	25mm BSPM	140psi / 965 kPa	75	DC3	MT04

### KEY FEATURES

- Easy to service float valves
- Full float protection
- 75mm drain cap at very base of trough so maximum amount of water will empty when draining
- Easy to service 1" float valve
- Raised float allows trough to fill completely



## Bare Round Water Troughs

CODE	CAPACITY (Litres)	DIMENSIONS	DRAIN	DRAIN CAP
PT12W	250	1000 DIA x 420H	75	DC3
PT10W	500	1200 DIA x 500H	75	DC3
PT11W	1,000	1650 DIA x 600H	75	DC3
PT13W	2,000	2100 DIA x 600H	75	DC3



# Stock Water Tank & Trough

CODE	DESCRIPTION	CAPACITY	DIMENSIONS	FLOAT INLET	DRAIN	DRAIN CAP	FLOAT COVER
SWT4500	Tank & Trough Combination	4500ltr	2500 DIA x 2000H	25mm BSPM	75	DC3	SWTC
SWT15	Trough Only - inc Float Valve & Cover	1500ltr	2500 DIA x 375H	25mm BSPM	75	DC3	SWTC

## KEY FEATURES

1. 25mm float valve mounted in bottom of wall to maintain level in trough
2. 75mm drain cap in trough
3. Inspection cover
4. 25mm tank inlet and 25mm float valve supplied
5. Full float cover to protect valve from stock damage
6. Inlet connection

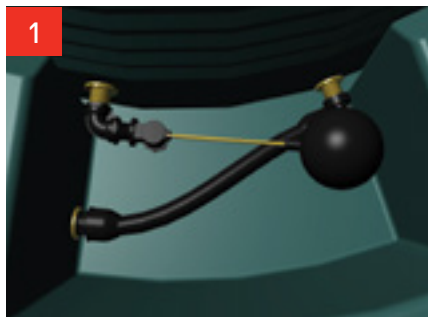

# Long Water Troughs

## Supa Troughs



CODE	DESCRIPTION	CAPACITY (Litres)	PRESSURE	DIMENSIONS (L x W x H)	FLOAT COVER	DRAIN CAP
SPT5	5 ft	250	140psi / 965 kPa	1500 x 600 x 375	SPTA	DC3
SPT9	9 ft	450	140psi / 965 kPa	2700 x 600 x 375	SPTA	DC3
SPT12	12 ft	600	140psi / 965 kPa	3700 x 600 x 375	SPTAL	DC3

### KEY FEATURES

- One-piece trough incorporating float cover
- Long lasting UV resistant polyethylene
- Flexible and durable
- Raised cover allows trough to fill fully
- 25mm Float Valve & Cover + 75mm Bung each end



## 'M' Series Troughs

CODE	CAPACITY (Litres)	DIMENSIONS (L x W x H)	FLOAT COVER
PTM31W	140	2400 x 460 x 175	PTMFC
PTM32W	100	1800 x 460 x 175	PTMFC
PTM33W	60	1200 x 460 x 175	PTMFC
PTM34W	35	750 x 460 x 175	PTMFC

### KEY FEATURES

- Long lasting UV resistant polyethylene
- Flexible and durable
- Stackable for storage
- Feed or water models available
- 15mm float valve and cover
- In built eyelets for securing to ground

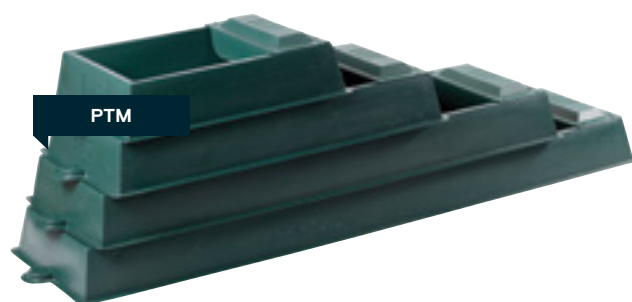

## Sweep Ballast Troughs



CODE	DESCRIPTION	CAPACITY	DIMENSIONS (L x W x H)	FLOAT COVER	BROOM	DRAIN PLUG
SWP250	Trough with 25mm Float Valve	250 ltr	3492 x 580 x 350	SWP250FC	STB250	DP2
SWP250-40	Trough with 40mm Float Valve	250 ltr	3492 x 580 x 350	SWP250FC	STB250	DP2
SWP450	Trough with 25mm Float Valve	450 ltr	3495 x 772 x 375	SWP450FC	STB450	DP2
SWP450-40	Trough with 40mm Float Valve	450 ltr	3495 x 772 x 375	SWP450FC	STB450	DP2
SWP450-50	Trough with 50mm Float Valve	450 ltr	3495 x 772 x 375	SWP450FC	STB450	DP2

### KEY FEATURES

- Easy cleaning - smooth sweep out end
- Flexible and durable
- Hinged float cover prevents any damage to inlet
- Tough double skin unit for extra strength
- 50mm Drain Plug
- Contoured brooms available for easy sweep out cleaning



\* SWP250 = approx 240 Litres  
 SWP450 = approx 300 Litres



# Polychoice Troughs



CODE	PROFILE	CAPACITY (Litres)	DIMENSIONS (L x W x H)	FLOAT INLET	PRESSURE	DRAIN	DRAIN PLUG
PCTL12	Long	160	1200 x 600 x 375	25 BSPM	150psi / 1034kPa	50	DP2
PCTL24	Long	360	2400 x 600 x 375	25 BSPM	150psi / 1034kPa	50	DP2
PCTR22	Round	220	1000 DIA x 400H	25 BSPM	150psi / 1034kPa	50	DP2
PCTR66	Round	660	1500 DIA x 500H	25 BSPM	150psi / 1034kPa	50	DP2
PCTR120	Round	1,200	1900 DIA x 530H	25 BSPM	150psi / 1034kPa	50	DP2

## KEY FEATURES

- Enclosed float compartment
- Stackable
- Flexible & Durable
- 20mm Float Valve



# Feed Troughs

## Calf Feeding - Dry Feed Troughs

CODE	CAPACITY	DIMENSIONS (L x W x H)	POLY INSERT
PTC36F	68kg	2400 x 300 x 600	PTC36I
PTC37F	52kg	1800 x 300 x 600	PTC37I

### KEY FEATURES

- Height of frame 600mm
- Galvanised frames with splayed legs for greater stability
- Provision for pegging down



## 'M' Series Troughs

CODE	CAPACITY (Litres)	DIMENSIONS (L x W x H)
PTM31F	140	2400 x 460 x 185
PTM32F	100	1800 x 460 x 185
PTM33F	60	1200 x 460 x 185
PTM34F	35	750 x 460 x 185

### KEY FEATURES

- Long lasting UV resistant polyethylene
- Flexible and durable
- Stackable for storage
- Feed or water models available
- In built eyelets for securing to ground



## Continuous Dry Feed Trough

CODE	DESCRIPTION	DIMENSIONS (L x W x H)	ANCHORING PEGS (6 pack)
CFT8	No Ends	2320 x 230 x 85	FTP9
CFT8E	Ends Both Sides	2320 x 230 x 85	



## Molasses Feeder

CODE	DESCRIPTION
PT05	Licker Drum 100 ltr
PT05C	Case only
PT05R	Roller only

### KEY FEATURES

- Urea feeding and bloat control
- Removable roller for cleaning
- Floating roller - no metal bearings

**\*Caution:** Special care should be taken when administering urea and other supplements, excess consumption can cause death



# Footrot Baths

## Standing Type



CODE	DIMENSIONS (L x W x H)	CAPACITY (Max Litres)
FRB	2530 x 1000 x 200	300

### KEY FEATURES

- Control hoof diseases in sheep and goats
- Use with portable yard to keep animals confined
- Lightweight for ease of handling
- Non slip dimpled floor
- End to end linking feature
- Will not rot, rust or flake and fully chemical resistant

\*Not recommended for cattle and horses



## Race Type

CODE	DIMENSIONS (L x W x H)	CAPACITY (Max Litres)
RFRB	2400 x 480 x 200	80

### KEY FEATURES

- Control hoof diseases in sheep and goats
- Unique pyramid shaped rib through centre of trough
- Keep hooves either side of the trough
- Added strength and support to trough floor
- Reduce amount of solution needed to treat stock
- Non slip dimpled floor
- End to end linking feature is ideal for placing in sheep race
- Will not rot, rust or flake and fully chemical resistant

\*Not recommended for cattle and horses

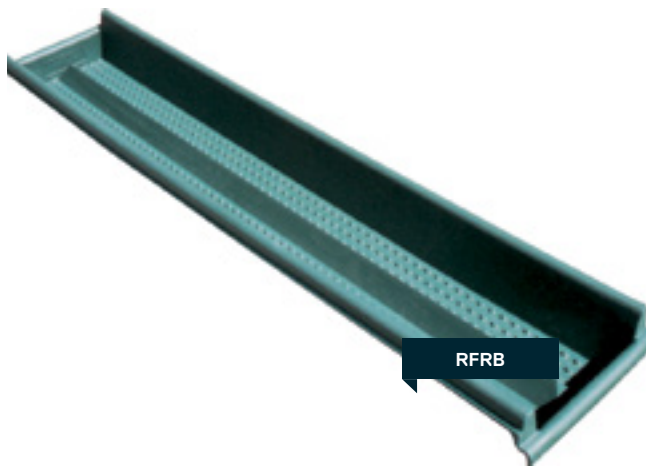

# Trough Spares

## Float Valves

CODE	DESCRIPTION
AFV2	25mm (1") Plastic Sleeve Valve to suit Supa Troughs, Master Tubs and Longline Troughs Pressure range 0 - 965kpa (0 - 140psi)
AFV2RKIT	AFV2 Repair Kit O-Ring, Washer pin and Arm
AFV2SEAL	Float Valve Seal AFV2
PMF345	Float to suit AFV3, AFV4, AFV5
AFV3B	32mm (1¼") Plastic Sleeve Valve - High Volume incl 40mm (1½") M & F Brass outlet. Pressure range 0 - 450kpa (0 - 65psi)
AFV4B	40mm (1½") Plastic Sleeve Valve - High Volume incl 50mm (2") M & F Brass Outlet. Pressure range 0 - 450kpa (0 - 65psi)
AFV5B	50mm (2") Plastic Sleeve Valve - High Volume incl 2½" M & F Brass Outlet. Pressure range 0 - 450kpa (0 - 65psi)
AFV6	25mm (1") Plastic piston valve to suit MT2, MT6 (fitted prior to May 2009) Pressure range 0 - 1400kpa (0 - 200psi)
AFV6L	25mm piston valve long arm 1400KPA rating
AFV0L	15mm (1/2") Philmac Float Valve - Long Arm For PT49W, PT50W & M Troughs
JFV20	20mm Jobe Float Valve for PolyChoice Troughs Pressure range 0 - 1034kpa (0 - 150psi)

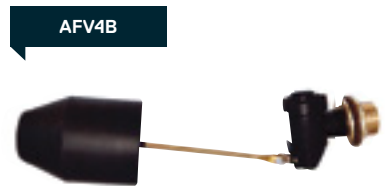

## Drain Caps & Plugs

CODE	DESCRIPTION
DC2	50mm (2") Drain Cap for all longline troughs, PT49W & PT50W
DCSE	Seals only for 50mm (2") Drain Cap
DC3	75mm (3") Drain Cap
DC3SE	Seals only for 75mm (3") Drain Cap
DP2	50mm (2") Drain Plug
DPSE	Seals only for 50mm (2") Drain Plug
DP4B	100mm (4") Brass drain plug to suit MT45 only
PTWK6	40mm (1½") Joiner for 16' and 12' Longline Water Troughs (inc. 50mm Uniseals and pipe)
TSPK	Trough Spare Parts Kit - Inc. DC3 x 5, DP2 x 5, DC2 x 5, AFV2 x 2, DC3SE x 3, Lynchpin x 5
FTP9	Anchoring Pegs for continuous troughing (Pack of 6)



## Float Covers

CODE	SUITS
PTMFC	PTM31W, PTM32W, PTM33W, PTM34W
MT04	MT45
MT05	MT24
MTFC	MT2, MT6, MT12
LLFC	Longline Troughs
SWTC	SWT4500, SWT15
SPTA	SPT5, SPT9
SPTAL	SPT12
SWP250FC	SWP250, SWP250-40, SWP250-50
SWP450FC	SWP450, SWP450-40, SWP450-50



# Grain Feeders & Accessories

## Hay & Grain Feeder

CODE	DIMENSIONS (L x W x H)
HGF13	1300 x 1150 x 1200

### KEY FEATURES

- Holds one full hay bale
- Reduce waste
- Protect feed from rodents and pests



## Grain Saver

CODE	DESCRIPTION	DIMENSIONS
GRF400	Trough 400 ltr	1800 DIA x 350H
FTL2000	Lid for Hay Ring (Heritage Green)	2180 DIA



\*Hay ring not included



### KEY FEATURES

- Protect feed from rodents and pests
- Raised centre keeps feed easy to reach for livestock

## Grain Hopper

CODE	DESCRIPTION	DIMENSIONS (L x W x H)
GAB2	Grain Hopper (Auger Boot) fits 4-10 inch Auger	1100 x 1200 x 540
GABS	Strap & Buckle Only	

### KEY FEATURES

- Wide support base and low profile
- Suits augers up to 240mm (9.5")
- Crease resistant - flexes back into shape
- Equipped with strap to hold onto auger



## Shovel

CODE	DESCRIPTION	DIMENSIONS
GS40	Grain Shovel	1100 H

### COLOUR RANGE



# Calf Milk Feeders



CODE	DESCRIPTION	CAPACITY (Litres)	DIMENSIONS (L x W x H)	BRACKETS & MOUNTS	TEAT & CAP	TEAT
MBP	Single Teat Milk Bottle	2	100 x 180 x 250		PCT/SCIT	PCT
MM1P	Single Teat Feeder	5	200 x 200 x 300		PCT/SCIT	PCT
MM5P	5 Teat Feeder - Divisional	30	270 x 760 x 300	MM5BR	PCT/SCIT	PCT
MM8P	8 Teat Feeder - Divisional	40	340 x 1130 x 300	MM12BR	PCT/SCIT	PCT
MM12P	12 Teat Feeder - Divisional	70	540 x 1260 x 320	MM12BR	PCT/SCIT	PCT
MM13P	13 Teat Feeder - Divisional	70	280 x 1800 x 330	MM12BR	PCT/SCIT	PCT
MM20P	20 Teat Feeder - Divisional (Freestanding)	100	1110 x 1110 x 330		PCT/SCIT	PCT
CF5P	5 Teat Feeder - No Divisions	25	300 x 590 x 360	MM5BR	PCT/SCIT	PCT
CF12P	12 Teat Feeder - No Divisions	70	500 x 1155 x 340	MM12BR	PCT/SCIT	PCT
CF13P	13 Teat Feeder - No Divisions	70	280 x 1800 x 330	MM12BR	PCT/SCIT	PCT

## KEY FEATURES

- Generous spacing between teats
- Teat caps easily unscrew to wash out feeder
- Galvanised hanging brackets to suit rail spacing
- UV stabilised poly for long outdoor use

CF13P



MM12P



MM1P



CF5P



MM20P



MM8P



MM5P



MM5PPNK



MBP



Available in Pink (MM5 & MM8)

# Lamb Milk Feeders

CODE	DESCRIPTION	CAPACITY (Litres)	DIMENSIONS (L x W x H)	BRACKETS & MOUNTS	TEATS & CAPS	TEATS
FLBF	Clear Single Teat Milk Feeders	1	80 x 80 x 300		LT/BC	LT
MBL	Single Teat Milk Bottle	2	100 x 180 x 250		LT/SC	LT
MM1L	Single Teat Feeder	5	200 x 200 x 300		LT/SC	LT
MM5L	5 Teat Feeder - Divisional	30	270 x 760 x 300	MM5BR	LT/SC	LT
MM8L	8 Teat Feeder - Divisional	40	340 x 1130 x 300	MM12BR	LT/SC	LT
MM12L	12 Teat Feeder - Divisional	70	540 x 1260 x 320	MM12BR	LT/SC	LT
MM13L	13 Teat Feeder - Divisional	70	280 x 1800 x 330	MM12BR	LT/SC	LT
MM20L	20 Teat Feeder - Divisional (Freestanding)	100	1110 x 1110 x 330		LT/BC	LT
CF5L	5 Teat Feeder - No Divisions	25	270 x 760 x 300	MM5BR	LT/SC	LT
CF12L	12 Teat Feeder - Not Divisions	70	500 x 1155 x 340	MM12BR	LT/SC	LT
CF13L	13 Teat Feeder - No Divisions	70	280 x 1800 x 330	MM12BR	LT/SC	LT



## KEY FEATURES

- Generous spacing between teats
- Teat caps easily unscrew to wash out feeder
- Galvanised hanging brackets to suit rail spacing
- UV stabilised poly for long outdoor use



## Milk Test Buckets

CODE	CAPACITY (Litres)	DIMENSIONS	SEAL	LID & SEAL
PTB25	25	300 DIA x 490H	PTBS	PTBL25
PTB32	32	330 DIA x 510H	PTBS	PTBL32

## KEY FEATURES

- Stainless steel handles
- Replacement Seals Available
- Pipe attachments to suit 5/8" or 3/4" tubing



# Mobile Gravity Milk Feeders



CODE	DESCRIPTION	CAPACITY	DIMENSIONS (L x W x H)	MANIFOLD
MG40P	40 Teat Feeder - single axle	400 ltr	2200 x 1500 x 1200	MG4M
MG50P	50 Teat Feeder - single axle	400 ltr	2800 x 1500 x 1200	MG5M
MG50TAP	50 Teat Feeder - dual axle	400 ltr	2800 x 1500 x 1200	MG5M
MG50LTAP	50 Teat Feeder - dual axle	800 ltr	2800 x 1500 x 1200	MG5M
MG60P	60 Teat Feeder - dual axle	800 ltr	3100 x 1550 x 1500	MG6M
MG400T	400 ltr (tank only)	400 ltr		
MG800T	800 ltr (tank only)	800 ltr		



## Mobile Mixer and Tanker

CODE	DESCRIPTION	DIMENSIONS (L x W x H)
MMT400	400 ltr - 2.5HP Pump	2200 x 1500 x 1200



## Riverina Milk Transporter

CODE	DESCRIPTION	DIMENSIONS (L x W x H)
RMT	200 ltr - single axle	1700 x 1200 x 1000



### KEY FEATURES

- Fully hot dipped galvanised trailers
- Screw on teats can be replaced with blanks
- Adjustable fold away jockey wheel
- Built in backwash for all trailer units
- Self cleaning washing head used in tank
- Large hinged filling lids



# Fence & Stable Drinkers



CODE	FENCE BRACKETS	CAPACITY (Litres)	DIMENSIONS (L x W x H)	BRACKETS & MOUNTS	DRAIN CAP
PT48W	-	8	300 x 300 x 224	PT14BR	PT04WC
PT48WB	Yes	8	300 x 300 x 224	PT14BR	PT04WC
PT49W	-	25	440 x 380 x 350	PT49BRS	DC2
PT49WB	Yes	25	440 x 380 x 350	PT49BR	DC2
PT50W	-	45	490 x 430 x 440	PT49BRS	DC2
PT50WB	Yes	45	490 x 430 x 440	PT49BRS	DC2
PT90W	Yes	90	550 x 1090 x 400	PT90BRS	DC2

## KEY FEATURES

- Drain cap for easy cleaning
- Fix directly to the wall or brackets available for fence hanging
- Stylish colours available



## Fence & Stable Feeders

CODE	DESCRIPTION	CAPACITY (Litres)	DIMENSIONS (L x W x H)	BRACKETS & MOUNTS
PT02	Fitted with fence brackets	45	540 x 410 x 380	PT49BRS
PT02FS	Fitted with wall mount brackets	45	540 x 410 x 380	PT02STBR
PT03	Hayrack (suitable to hang on fence)		600 x 500 x 700	PT03R
PT14	Fence Feeder 'D' Type	32	440 x 400 x 250	PT14BR
PT15	Corner Feeder	32	450 x 450 x 270	PT14BR
PTF18	Tyre Feeder	18	350 DIA x 195H	

## COLOUR RANGE



# Teats & Accessories

## Accessories

CODE	DESCRIPTION
HL4	Hinged Lid 400mm for All MG40, MG50 & MG60 Calf Feeders
JWK	Jockey Wheel Kit - to suit Mobile Gravity Calf Feeder
MG2W	16" Wheel only for MG26 Calf Feeder (no axle)
MG4W	18" Wheel only for MG40, MM50, MG50 & Calf Feeder (no axle) each
MG4M	20 Teat manifold for MG40 Calf Feeder (Specify front or rear)
MG5M	25 Teat manifold for MG50 Calf Feeder (Specify front or rear)
MG6M	30 Teat manifold for MG60 Calf Feeder (Specify front or rear)
MGD1	Mud guards for single wheel calf feeders (Set of 2)
MGD2	Mud guards for tandem wheel calf feeders (Set of 2)
SL5	Screw lid - complete 355mm (suits RMT)



HL4



LT/BC



LT/SC



PCT/SCIT

## Brackets

CODE	DESCRIPTION
MM5BR	Brackets to suit MM5 and CF5 (Set of 2)
MM12BR	Brackets to suit MM8, MM12, MM13, CF12 & CF13 (Set of 2)
PT14BR	Set of Brackets to suit Fence Feeders PT14, PT15, PT48WB
PT49BR	Set of Brackets to suit PT49WB, PT50WB & PT02
PT02STBR	Set of wall Mount Brackets to suit PT02FS
PT03R	Galvanised Rack to suit PT03 Hayrack (Set of 2)

## Accessories

CODE	DESCRIPTION
PTWK7	Spacesaver 15mm (½") piston valve for PT48W (Pressure range 0 - 850kpa (0 - 120psi))

## Teats and Caps

CODE	DESCRIPTION
PCT	Peach Teats
SCITP	Screw Cap with internal thread for Peach Teats
PCT/SC	Peach Calf Teat pulled through Screw Cap
LT	Lamb Teat
LT/BC	Lamb Teat through Bottle Cap
LT/SC	Lamb Teat through Screw Cap
SCL	Screw Caps for Lamb Teats
SCP	Screw Cap for Peach Teat

## Drain Caps

CODE	DESCRIPTION
PT04WC	25mm (1") Drain Cap for PT48W Drinkers
DC2	50mm (2") Drain Cap for PT49W & PT50W Drinkers
DCSE	Seals only for 50mm (2") Drain Cap

## Milk Transfer Pump Kit

CODE	DESCRIPTION	FLOW (LPM)
MTP110	Milk Transfer Submersible pump kit 12V	40



MTP110

# Feed Storage Bins

## Feed Storage Bin & Tubs



CODE	DESCRIPTION	DIMENSIONS (L x W x H)	WITH LID	REPLACEMENT LID
FSB200	Feed Storage Bin 200 ltr - Hinged Lid	520 x 860 x 560		
FST100	Storage Tub 100 ltr	1000 X 300 X 580	FST100L	FSTL1020
FST200	Storage Tub 200 ltr	1000 X 570 X 580	FST200L	FSTL1020
FST300	Storage Tub 300 ltr	1165 X 730 X 580	FST300L	FSTL30



\*Image shown with optional lid

## Handi Steps

CODE	DESCRIPTION	DIMENSIONS (L x W x H)
HSP	120kg SWL	700 x 520 x 670

\* Recommended for indoor use only



# Buckets & Scoops

## Buckets

CODE	VOLUME
HB16	16 ltr
POB20	20 ltr with level measurements



## Feed Scoops

CODE	VOLUME
PSC	2.5kg of pellets



COLOUR RANGE		
LME	PNK	YEL
PUR	HGR	

## KEY FEATURES

- Available in a range of stylish colours
- Large capacity
- Sturdy handles
- Stackable

# Dog Houses



CODE	DESCRIPTION	DIMENSIONS (L x W x H)	OPENING SIZE
TDD1	Dinkum Doghouse 1	1050 x 780 x 690	390 DIA
TDD2	Dinkum Doghouse 2	680 x 460 x 640	180 x 260
TDD3	Log Cabin Doghouse	1060 x 860 x 780	280 x 400

## KEY FEATURES

- Cooler in summer, warmer in winter
- Rear venting to create airflow
- Hygienic - easily washed out

## COLOUR RANGE

\*TDD1/TDD2 Only



# Tractor Roofs

CODE	DESCRIPTION	DIMENSIONS (L x W x H)	MOUNTING BRACKET - 2 POST	MOUNTING BRACKET - 4 POST
TR0	Small (Ride on mowers)	1200 x 850 x 120	MTR0-2	MTR0-4
TR1	Medium (Tractors up to 45HP)	1530 x 1140 x 150	MTR1-2	MTR1-4
TR2	Large (Tractors over 45HP)	1830 x 1500 x 200	MTR2-2	MTR2-4
MTR2-LGEKIT	Large kit required in addition for wide post ROPS			

## COLOUR RANGE



## KEY FEATURES

- Designed for ROPS frames
- 3 sizes available



# Produce Bins & Liners



CODE	DESCRIPTION	CAPACITY (Litres)	DIMENSIONS (L x W x H)	LID
PPB100	Produce Bin	1,000	1190 x 1190 x 1010	PPBL
PPB100FC	Produce Bin incl fork plates	1,000	1190 x 1190 x 1010	PPBL
PBL85	Liner Only	850	1110 x 1110 x 760	PBLD
PBL100	Liner Only	1,000	1110 x 1110 x 885	PBLD
PBL145	Liner Only	1,450	1110 x 1110 x 1200	PBLD
GBL	Grape Bin Liner	2,850	GBLLIDN	

## KEY FEATURES - PPB100

- Stackable when full, nest them empty
- Optimum height for hand picking
- FEA analysis testing completed for strength
- Ideal pallet size for transporting
- Forklift access channels
- Food grade polyethylene

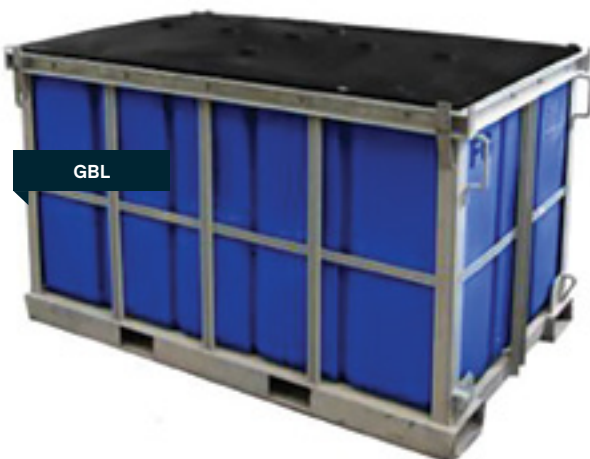

\*Steel frames not included, only shown for illustrative purposes

# Bulk Storage

## Bulka Bins



CODE	DESCRIPTION	CAPACITY (M <sup>3</sup> )	DIMENSIONS (L x W x H)	LID
BB12	Galvanised frame	1.2	1200 x 1500 x 1600	BBLID
BB12XL	Galvanised frame - extended legs	1.2	1200 x 1500 x 2300	BBLID
BB12L	Liner only	1.2		BBLID
BB16	Galvanised frame	1.6	1200 x 1500 x 1860	BBLID
BB16XL	Galvanised frame - extended legs	1.6	1200 x 1500 x 2560	BBLID
BB16L	Liner only	1.6		BBLID

PRODUCT	BB12	BB16
Wheat & Meatmeal	960kg	1200kg
Barley	750kg	1000kg
Oats	600kg	800kg
Urea	876kg	1200kg
Lucerne	300kg	400kg
Calf & Pig Pellets	800kg	1050kg

### KEY FEATURES

- All galvanised forklift frame - lifts on/off easily
- Stainless steel chute with rodent and weather resistant outlet
- Extended leg models allow for bag filling
- Suitable for grains, pellets and more



## Maxi Bins

DRY OUTLET	LIQUID OUTLET	CAPACITY (M <sup>3</sup> )	DIMENSIONS (L x W x H)
MB60P	MB60L	0.6	1165 x 1165 x 1450
MB100P	MB100L	1.0	1165 x 1165 x 1870
MB150P	MB150L	1.5	1165 x 1165 x 2235
MB200P	MB200L	2.0	1165 x 1165 x 2655



# Silomaster



DRY OUTLET	LIQUID OUTLET	CAPACITY (Litres)	DIMENSIONS
SM5000D	SM5000L	5,000	2380DIA x 3030H
SM7500D	SM7500L	7,500	2380DIA x 3620H
SM10000D	SM10000L	10,000	2380DIA x 4210H



## Silomaster - Heavy Duty

DRY OUTLET	LIQUID OUTLET	CAPACITY (Litres)	DIMENSIONS
SM5000HDD	SM5000HDL	5,000	2380DIA x 3530H
SM7500HDD	SM7500HDL	7,500	2380DIA x 4115H
SM10000HDD	SM10000HDL	10,000	2380DIA x 4705H

\*Suitable to hold liquids up to 1.4SG

### KEY FEATURES

- Sturdy galvanised steel frame and rust proof poly tank
- Integrated forklift channels
- Rodent and weather proof
- Screw lid

### COLOUR RANGE



## Dry Feed Frame

CODE	CAPACITY (Litres)	DIMENSIONS
SMDF5000	5,000	2380DIA x 3525H
SMDF7500	7,500	2380DIA x 4115H
SMDF10000	10,000	2380DIA x 4705H



# Silomaster Large Capacity



CODE	CAPACITY (Litres)	DIMENSIONS
SM20000L	20,000	3450DIA x 4376H
SM25000L	25,000	3450DIA x 4923H
SM30000L	30,000	3450DIA x 5471H

## KEY FEATURES

- Sturdy galvanised steel frame and rust proof poly tank
- Integrated forklift channels
- Rodent and weather proof
- Screw lid
- 100mm 90 deg fitting

## COLOUR RANGE

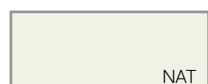

NAT



LGY

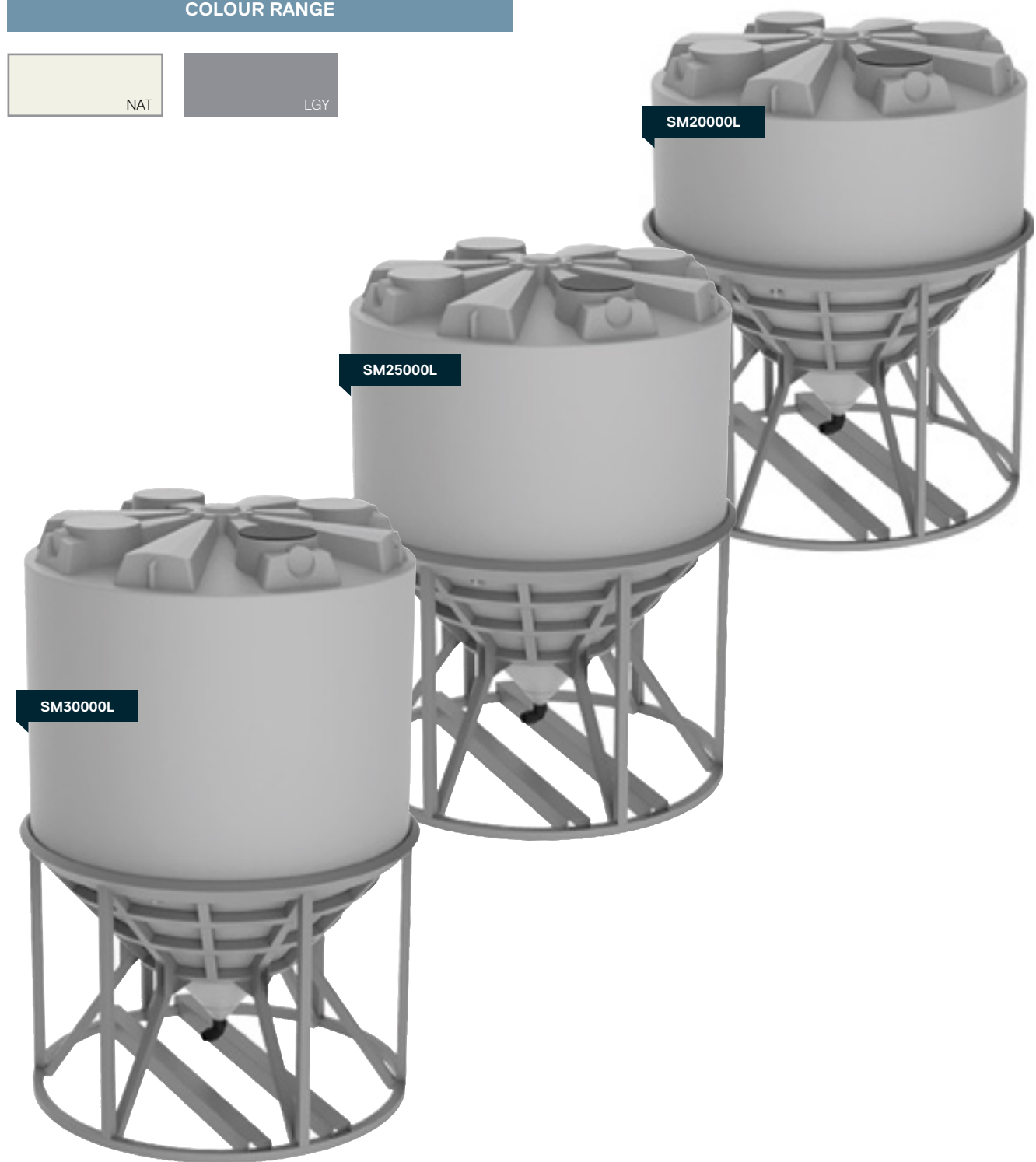

AGRICULTURE



# Vehicle Storage

## Vehicle Water Tanks



CODE	DESCRIPTION	CAPACITY (Litres)	DIMENSIONS (L x W x H)
HT28	Handi Tank only	28	415 x 240 x 380
HT28P	Handi Tank with mounting plate	28	415 x 240 x 380
TWT60	Truck Water Tank only	60	600 x 390 x 390
TWT60S	Truck Water Tank with mounting bracket and strap	60	600 x 390 x 390
TWTWTAP	Tap only for Truck Water Tanks		
TWTS	Mounting Brackets & Straps for truck water tank		

### KEY FEATURES

- 20mm tap for dispensing
- 20mm cap at top for easy filling

### COLOUR RANGE

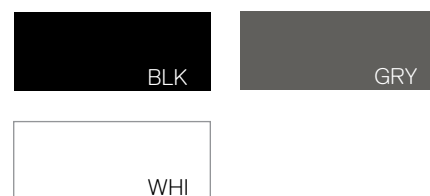

## Tool Boxes

CODE	DESCRIPTION	CAPACITY (Litres)	DIMENSIONS (L x W x H)
BUC14	B'Ute Tool Box - Small	140	970 x 400 x 360
BUC26	B'Ute Tool Box - Large	266	1170 x 570 x 400
TBC20	Tradesman Box	200	980 x 390 x 600
TBC20FH	Tradesman Box Friction Hinge	200	980 x 390 x 600

### KEY FEATURES

- Flush mounted zinc hardware
- Raised weather resistant lid seal
- Removable internal tray included

### COLOUR RANGE



# Diesel Ute Packs

## Diesel Essential Cube Ute Packs



CODE	CAPACITY DIESEL (Litres)	DIMENSIONS (L x W x H)	PUMP*	DIESEL PUMP FLOW (LPM)	HOSE LENGTH (m)	AUTO TRIGGER NOZZLE
DMPQ400E	400	930 x 1200 x 685	DP50PUMP	50	4	Yes

\*Refer to Diesel Pump page for full pump details



DMPQ400E

## Diesel Essential Ute Packs

CODE	CAPACITY (Litres)	DIMENSIONS (L x W x H)	PUMP*	PUMP FLOW (LPM)	HOSE LENGTH (m)	AUTO TRIGGER NOZZLE	MOUNTING FRAMES
DMP100E	100	770 x 540 x 500	DP50PUMP	50	4	Yes	DM100MF
DMP200E	200	1000 x 750 x 605	DP50PUMP	50	4	Yes	DM200MF
DMP400E	400	1620 x 750 x 665	DP50PUMP	50	4	Yes	DM400MF
DMP600E	600	1720 x 890 x 755	DP50PUMP	50	4	Yes	DM600MF
DMP800E	800	1720 x 890 x 925	DP50PUMP	50	4	Yes	DM800MF

\*Refer to Diesel Pump page for full pump details

### KEY FEATURES

- Up to 50LPM Italian Piusi pump
- Lockable lid
- UV protected
- Earth strap
- Isolation switch
- 4m Diesel hose
- Diesel auto trigger nozzle
- Alligator clips

### OPTIONAL EXTRAS

- Gas Struts - Only available on cube ute packs
- Fuel Gauge
- Strainer
- Bund available - cube ute packs



DMP800E

DMP600E

DMP400E

DMP200E

DMP100E

# Diesel Transfer Tanks

## Transfer Tank & 12V Pump (up to 50LPM)

CODE	CAPACITY (Litres)	DIMENSIONS (L x W x H)	VOLTAGE	POWER (kW)	PUMP CODE	FLOW (LPM)
DMP600	600	1200 x 1050 x 715	12	0.3	DP50PUMP12V-ASY	50
DMP800	800	1450 x 1200 x 740	12	0.3	DP50PUMP12V-ASY	50
DMP1200	1200	1450 x 1200 x 1000	12	0.3	DP50PUMP12V-ASY	50
DMP2000	2000	1900 x 1450 x 1100	12	0.3	DP50PUMP12V-ASY	50
DMP3000	3000	2100 x 1500 x 1200	12	0.3	DP50PUMP12V-ASY	50

## Transfer Tank & Fastflow 12V Pump (up to 85LPM)

CODE	CAPACITY (Litres)	DIMENSIONS (L x W x H)	VOLTAGE	POWER (kW)	PUMP CODE	FLOW (LPM)
DMPF600	600	1200 x 1050 x 715	12	0.5	DP85PUMP12V	85
DMPF800	800	1450 x 1200 x 740	12	0.5	DP85PUMP12V	85
DMPF1200	1200	1450 x 1200 x 1000	12	0.5	DP85PUMP12V	85
DMPF2000	2000	1900 x 1450 x 1100	12	0.5	DP85PUMP12V	85
DMPF3000	3000	2100 x 1500 x 1200	12	0.5	DP85PUMP12V	85

## Transfer Tank & 24/12V Pump (70/35LPM)

CODE	CAPACITY (Litres)	DIMENSIONS (L x W x H)	VOLTAGE	POWER (kW)	PUMP CODE	FLOW (LPM)
DMPD600	600	1200 x 1050 x 715	12/24	0.42/0.15	DP1224PUMP12V	70/35
DMPD800	800	1450 x 1200 x 740	12/24	0.42/0.15	DP1224PUMP12V	70/35
DMPD1200	1200	1450 x 1200 x 1000	12/24	0.42/0.15	DP1224PUMP12V	70/35
DMPD2000	2000	1900 x 1450 x 1100	12/24	0.42/0.15	DP1224PUMP12V	70/35
DMPD3000	3000	2100 x 1500 x 1200	12/24	0.42/0.15	DP1224PUMP12V	70/35

## Transfer Tank & 240V Pump (100LPM)

CODE	CAPACITY (Litres)	DIMENSIONS (L x W x H)	VOLTAGE	POWER (kW)	PUMP CODE	FLOW (LPM)
DMP1200-240V	1200	1450 x 1200 x 1000	240	750	DP100-240V	100
DMP2000-240V	2000	1900 x 1450 x 1100	240	750	DP100-240V	100
DMP3000-240V	3000	2100 x 1500 x 1200	240	750	DP100-240V	100

## Bare Tank

CODE	CAPACITY (Litres)	DIMENSIONS (L x W x H)	SKIDS
DM1200	1200	1450 x 1200 x 1000	SKD1200
DM2000	2000	1900 x 1450 x 1100	SKD2000
DM3000	3000	2100 x 1500 x 1200	SKD3000



### KEY FEATURES

- High quality Piusi Italian pump
- Lockable filling port
- Auto trigger nozzle and swivel
- Stainless steel pin mounting feet to secure to trailer or flat bed
- 4 metre Diesel hose and leads
- \*Refer to Diesel Pump page for full pump details

# Diesel Trailer Packages



CODE	CAPACITY (Litres)	TANK DIMENSIONS (L x W x H)	TRAILER DIMENSIONS (L x W x H)	PUMP*	PUMP FLOW LPM	HOSE LENGTH (m)	AUTO TRIGGER NOZZLE
DMPFT1200	1200	1450 x 1200 x 1000	3940 x 1770 x 1500	DP85PUMP	85	6	Yes
DMPFT2000	2000	1900 x 1450 x 1200	4460 x 1970 x 1650	DP85PUMP	85	6	Yes

## KEY FEATURES - TRAILER

- Hot dip galvanised dual axle trailer
- 5 Stud Wheel Pattern
- Electric brakes on 2000 ltr unit
- Road pack including brakes and LED lights
- Emergency breakaway protection
- Compliance plate - road registrable

## KEY FEATURES - TANK AND PUMP

- 85LPM 12V Diesel pump with by-pass valve and integrated on/off switch
- Auto shut off nozzle with 6m hose and reel
- 4m battery leads
- Breather vent
- 400mm 1/4 turn hinged lid
- Trailer mounted toolbox to protect the hose, pump and nozzle
- \*Refer to Diesel Pump page for full pump details

DMPFT1200T



Optional 10m retractable Diesel hose reel



# Diesel Single Skin Smooth Wall Tanks



CODE	CAPACITY (Litres)	DIMENSIONS
DSW5000LGY	5,000	1800 DIA x 2300 H
DSW7000LGY	7,000	2200 DIA x 2300 H
DSW10000LGY	10,000	2480 DIA x 2450 H

## KEY FEATURES

- Clock Type Level Gauge Option to upgrade
- Galvanised Pipe work
- 2" Aluminium Cam Lock
- 2" Brass Outlet and Ball Valve
- Earth Rod
- Breather Vent
- Australian Made
- Fill rate maximum 250LPM
- Overfill protection

\* NOTE: Please seek advice of local authorities for positioning on site

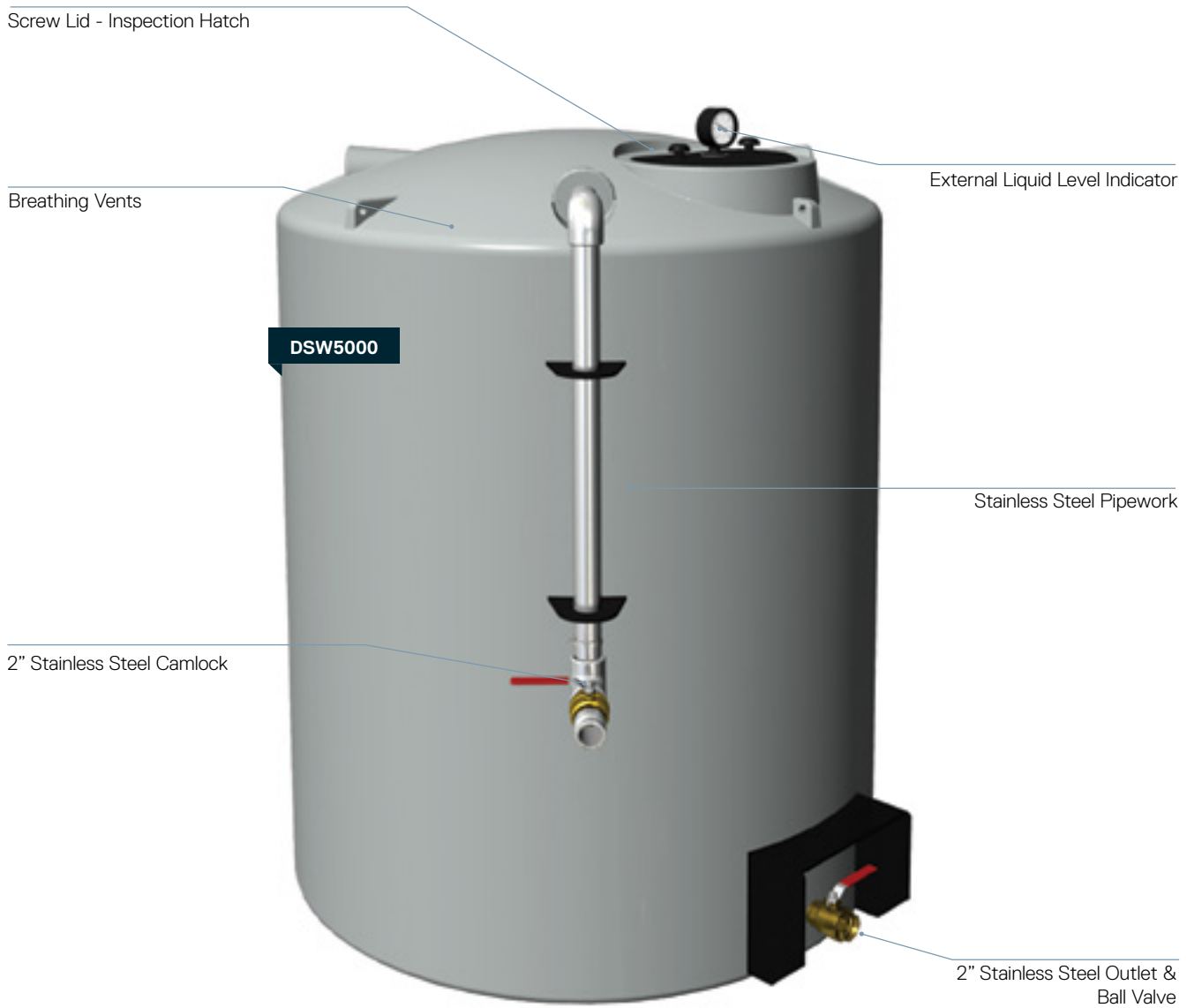

# Diesel Self Bunded Tank

Three models available: Essential, Ranger or Quantum

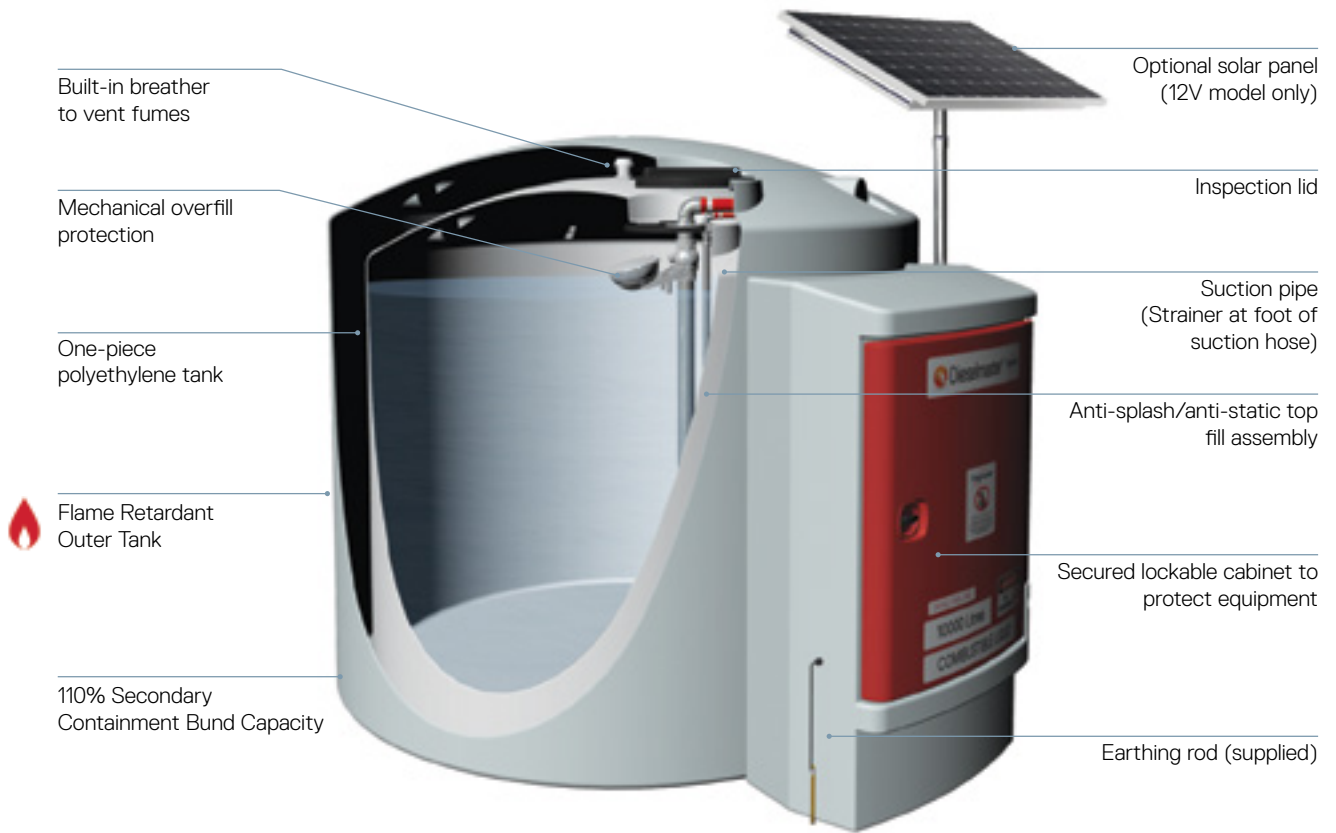

## Cabinet Details (Essential Model Shown)



(Image for illustrative purposes only)

FEATURES	ESSENTIAL	RANGER	QUANTUM
Power supply - 240V	✓	✓	✓
Power supply - 12V	-	✓	-
70LPM Piusi pump	✓	✓	✓
6mtr dispensing hose with auto-shut off trigger nozzle	✓	✓	-
10mtr hose reel with auto-shutoff trigger nozzle	-	-	✓
Auto-shutoff nozzle holster	-	✓	✓
30 micron clear water capture filter - to 150LPM	✓	✓	✓
2" camlock connection to fill - top fill assembly	✓	✓	✓
Anti-splash/anti-static top fill assembly	✓	✓	✓
Mechanical overfill protection	✓	✓	✓
High/Low level electronic audible alarm	-	✓	✓
Bund alarm	✓	✓	✓
110% secondary containment bund capacity	✓	✓	✓
Flame retardant outer tank material	✓	✓	✓
Digital level indicator	✓	✓	✓
Secured lockable cabinet to protect equipment	✓	✓	✓
Mechanical fluid meter to measure vehicle usage	✓	-	-
Digital fluid meter to measure vehicle usage	-	✓	✓
Power control box with auto time out (10mins) & emergency stop	-	✓	✓
Fuel management system for up to 120 users	-	-	✓

## Specifications

CODE	CAPACITY (Litres)	A	B	C	D
DMDS2300	2,300	1600	2160	2200	2120
DMDS3300	3,300	1800	2130	2200	2300
DMDS5000	5,000	2200	2080	2260	2750
DMDS7000	7,000	2500	2190	2350	3070
DMDS10000	10,000	2500	2520	2710	3062

## DIMENSIONS



# Diesel Dispensing Units

## Piisi ST Meter

CODE	FLOW RATE (LPM)	VOLTAGE	METER	NOZZLE	HOSE LENGTH (m)	HOSE DIAMETER	OUTLET (BSP)
STMETER240V	72	240v	K33	A80	4	25	25
STMETER12V	56	12v	K33	A80	4	20	20

The Piisi ST with Meter is a diesel transfer station for fixed installations with either an AC or DC pump, nozzle (manual or automatic) and a precision meter – K33, for safe and controlled refuelling operations.

Easy to install, this station can be used to fill mobile tanks or interact with distribution units.



### KEY FEATURES

- Ready to use
- Easy to install
- Sturdy structure
- High precision meter
- Available with both 12v or 240v pumps

## Piisi ST Box

CODE	FLOW RATE (LPM)	VOLTAGE	METER	NOZZLE	HOSE LENGTH (m)	HOSE DIAMETER	OUTLET (BSP)
STBOXMETER12V	80	12v	K33	A80	4	25	25
STBOXBASIC	70	240v	K33	A80	6	25	20
STBOXPRO	70	240v	A80	Auto	6	25	25

The Piisi ST Box is a diesel refuelling station, complete with pump, flow meter and filter, protected in a lockable metal housing.

The unit is complete with antistatic hose for diesel dispensing and an automatic nozzle.

The Pro model features electronic access control box ACCESS 85.



### KEY FEATURES

- Sturdy structure
- Lockable and safe
- Ready to use
- Filtration guaranteed
- Auto Shut-off Nozzle Holster

## Piisi Cube

CODE	FLOW RATE (LPM)	VOLTAGE	METER	NOZZLE	HOSE LENGTH (m)	HOSE DIAMETER	OUTLET (BSP)
CUBE56-12V	56	12v	K33	A60	4	25	25
CUBE70-240V	70	240v	K33	A60	6	25	20

The Piisi Cube is a mechanical fuel transfer dispenser for non-commercial use. The Cube contains a self-priming vane pump fitted with integrated bypass valve, automatic nozzle with swivel connection and integrated nozzle holder with start/stop pump lever.

### KEY FEATURES

- Sturdy structure
- Mechanical meter
- Induction thermal-protected motor
- Overload protection
- Built-in mesh filter





# Diesel Pumps & Accessories

## Diesel Pumps

CODE	DESCRIPTION	VOLTAGE	POWER (kW)	FLOW (LPM)	INLET	OUTLET	WARRANTY (yrs)	KIT
DP50PUMP12V-ASY	50L Diesel Pump	12v	0.3	50	25mm	25mm	1	DP50K
DP72PUMP	Panther Diesel Pump	240v	0.5	72	25mm	25mm	1	DP72K
DP85PUMP	Fast Flow Diesel Pump	12v	0.5	85	25mm	25mm	1	DP80K
DP1224PUMP	Diesel Transfer Pump	12v/24v	0.42/0.15	70/35	25mm	25mm	1	DP3570K

## Pump Kits

CODE	CONTENTS
DP50K	Pump, 4m Hose & Automatic Shutoff Nozzle
DP72KA	Pump, Mechanical Meter, Water Capture Filter, 6m Hose, Automatic Shutoff Nozzle
DP85K	Pump, 4m Hose, Automatic Shutoff Nozzle
DP1224K	Pump, 4m Hose, Automatic Shutoff Nozzle



# Smart Diesel Dispensing

## Piusi MC Box B.Smart

Simple, intuitive, smart fuel management system. An intuitive and simple Fuel Management System – composed of hardware and software (app for drivers and a Cloud based web app for fleet managers), driven by Bluetooth technology to easily monitor and manage any fleet; from the biggest to the smallest.

CODE

BSFMS

## The All-In-One Fuel Management System

No need for software to be installed on a PC: B.SMART works in the Cloud and allows you to monitor all fuel transactions in real time, from any site where MCBOX B.SMART is installed. Communication between MCBOX B.SMART, Phone App and Cloud Software is simple.

When the driver opens the B.SMART App from his Android or iOS device, the smartphone or tablet automatically connects to MCBOX B.SMART to authorise refuelling.

During the refill, the driver can keep track of the quantity dispensed on his device and once finished, he can view the virtual receipt, which will also be sent in real time to the Cloud Software.

At the same time the fleet manager can, from the simple graphic interface of the Cloud Software, manage and monitor in real time all supplies made by distributors and on fleets of all sizes.

BSFMS



## Diesel Accessories

CODE	DESCRIPTION
ATN65	65LPM Diesel Auto Nozzle
ATN90	90LPM Diesel Auto Nozzle
BM35TNB-RES	35L AdBlue Reservoir Tank for Cube
BMCB-D	Diesel MC Box
BYS20	Strainer - suits all Ute Packs
CLG-D	Diesel Clock Level Gauge
D-CONNECT2KIT	Diesel Connection Hose to Kits
DCF25F	Clear Captor Filter Cartridge 150LPM
DCF25CLF	Clear Captor Filter Cartridge 70LPM
DHR10M25	10m Diesel Retractable Hose Reel
DH2025-4M	4m Diesel hose - 20 x 25 Male connectors
DH2025-6M	6m Diesel hose - 20 x 25 Male connectors
DH2020-4M	4m Diesel hose - 20 x 20 Male connectors
DH2020-6M	6m Diesel hose - 20 x 20 Male connectors
DFG200	Diesel Fuel Gauge 200L
DFG400	Diesel Fuel Gauge 400L
DFG600	Diesel Fuel Gauge 600L
DFG800	Diesel Fuel Gauge 800L
DMDMFC	Metal Filling Cap (Ute Pack)
DMDT	Digital Turbine Meter
DMLI	Diesel Level Indicator (OCIO)
DMM4	4 Digit Mechanical Meter
DMPQ400BUND	Diesel Cube Bund
DPM	Diesel Pulse Meter
FCV	Vented/Breather Filling Cap (Ute Pack)
MCBKEYS-RED	MC Box User Keys - Red Manager
MCBKEYS	MC Box User Keys (Pk 10)
MCBPCIF	MC Box PC Software & USB Convert
MCBSW	MC Box Software
MTN	Diesel Manual Nozzle
SPK	Solar Panel Kit
STRUT430MM-200N	Gas Strut to suit DMPQ range



DPM



DMDT



DMM4



BMCB-D



CLG-D



DHR10M25



ATN90



DCF25F

(head not included)

# AdBlue® Storage

## AdBlue® Portable Ute Packs



CODE	DESCRIPTION	CAPACITY (Litres)	DIMENSIONS (L x W x H)	PUMP	PUMP FLOW (LPM)	HOSE LENGTH (m)	MOUNTING FRAMES
BM100-B	Tank + 12 Volt Pump	100	770 x 540 x 500	B12V-COMET	17	4	DM100MF
BM200B-P12	Tank + 12 Volt Pump	200	1000 x 750 x 605	B12VP-P	35	4	DM200MF
BM400B-P12	Tank + 12 Volt Pump	400	1620 x 750 x 665	B12VP-P	35	4	DM400MF

## AdBlue® Single Skin Slimline Tanks

CODE	COLOUR	CAPACITY (Litres)	DIMENSIONS (L x W x H)
BMSL2000RPB	Rapid Blue	2,000	2590 x 750 x 2110
BMSL3000RPB	Rapid Blue	3,000	2870 x 940 x 2150
BMSL5000RPB	Rapid Blue	5,000	3590 x 1170 x 2110



## AdBlue® Accessories

CODE	DESCRIPTION
B12K-P	IBC Kit - 12V
BATN-P	AdBlue® Auto Shutoff Nozzle (Puisi)
BDM-P	AdBlue® Pluse Meter
BDRHP-P	AdBlue® Rotary Hand Pump
BMCB-A	AdBlue® McBox
BMHR8-P	AdBlue® Hose Reel Retractable 20mm x 8m
BMLI	Level Indicator (Ocio) AdBlue®
BMTN-P	Nozzle Manual AdBlue® - Plastic (Puisi)



## AdBlue® Single Skin Slimline Tank cabinet

CODE	DESCRIPTION	CAPACITY (Litres)	DIMENSIONS (L x W x H)	PUMP	PUMP FLOW (LPM)	HOSE LENGTH (m)
BMSL5000LGY-C	Slimline AdBlue® Tank - Cabinet	5,000	4140 x 1170 x 2110	B240VP-P	35	5

### KEY FEATURES

- Optimised Fleet Solutions for AdBlue® storage and dispensing to SCR/DEF equipped vehicles.
- Simplifies dispensing operation
- Plug 'n' play set up for fast installation



# Water Cartage

## Water Cartage Tanks



CODE	CAPACITY (Litres)	DIMENSIONS (L x W x H)	OUTLET
FTR600	600	1150 x 1130 x 740	40mm
FTR800	800	1400 x 1200 x 740	40mm
FTR1200	1200	1450 x 1200 x 1000	40mm
FTR2000	2000	1900 x 1450 x 1100	40mm
FTR3000	3000	2100 x 1500 x 1200	40mm



### KEY FEATURES

- Moulded internal baffles for vehicle stability
- Brass outlet
- Forklift galvanised skids available
- Tough and durable one-piece moulding
- 400mm 1/4 turn hinged lid
- Sits directly on any flat surface
- High strength, lightweight polyethylene construction
- Provision for strap or pin mounting



## Water Cartage Tanks - Ute Pack

CODE	CAPACITY (Litres)	DIMENSIONS (L x W x H)	OUTLET
FTR200	200	1050 x 750 x 600	25mm
FTR400	400	1680 x 750 x 600	25mm
FTR600U	600	1720 x 890 x 755	25mm
FTR800U	800	1720 x 890 x 925	25mm



### KEY FEATURES

- Moulded internal baffles for vehicle stability
- Brass outlet
- Mounting frames available
- Tough and durable one-piece moulding
- 140mm 1/4 turn hinged lid
- High strength, lightweight polyethylene construction
- Provision for strap or pin mounting
- Wear pads to allow airflow underneath and protect ute tray

# Compact Fire Fighting Packages



CODE	CAPACITY (Litre)	DIMENSIONS (L x W x H)	PUMP CODE	ENGINE/PUMP	STARTER	HP
FTRC200-25	200	1050 X 750 X 600	MB25L	Loncin/Onga	Pull Petrol	2.5
FTRC200-55	200	1050 X 750 X 600	B55H	Honda/Onga	Pull Petrol	5.5
FTRC400-25	400	1680 X 750 X 600	MB25L	Loncin/Onga	Pull Petrol	2.5
FTRC400-55	400	1680 X 750 X 600	B55H	Honda/Onga	Pull Petrol	5.5
FTRC600-25	600	1720 X 890 X 755	MB25L	Loncin/Onga	Pull Petrol	2.5
FTRC600-55	600	1720 X 890 X 755	B55H	Honda/Onga	Pull Petrol	5.5
FTRC800-25	800	1720 X 890 X 925	MB25L	Loncin/Onga	Pull Petrol	2.5
FTRC800-55	800	1720 X 890 X 925	B55H	Honda/Onga	Pull Petrol	5.5
FTRC800-65-T	800	1720 x 890 x 925	B65HT	Honda/Onga	Pull Petrol	6.5

## KEY FEATURES

- Mounting frames available
  - Tough and durable one-piece moulding
  - Sits directly on any flat surface
  - High strength, lightweight polyethylene construction
  - 12m hose with fire fighting nozzle
  - Wear pads to allow airflow underneath and protect ute tray
  - Provision for strap or pin mounting
- \*Refer to Water Cartage & Fire Fighting Pumps page 61 for full pump details



# Skid Mounted Fire Fighting Packages



CODE	CAPACITY (Litres)	STARTER	DIMENSIONS (L x W x H)	ENGINE*
FTRS600	600	Pull-Petrol	1800 x 1400 x 850	B65HT
FTRS600ES	600	Electric- Starter	1800 x 1400 x 850	B65HTES
FTRS800	800	Pull-Petrol	1900 x 1400 x 850	B65HT
FTRS800ES	800	Electric- Starter	1900 x 1400 x 850	B65HTES
FTRS1200	1200	Pull-Petrol	1900 x 1400 x 1100	B65HT
FTRS1200ES	1200	Electric- Starter	1900 x 1400 x 1100	B65HTES
FTRS2000	2000	Pull-Petrol	2100 x 1800 x 1200	B65HT
FTRS2000ES	2000	Electric- Starter	2100 x 1800 x 1200	B65HTES

## KEY FEATURES

- 6.5HP Honda twin-impeller pump
  - 36m hose reel and fire fighting nozzle included
  - Heavy duty galvanised skid frame
  - Fork on - fork off capability
  - Bottom fill manifold with 6m suction hose
  - Optional dust suppression nozzle kit available (DSN20K)
- \*Refer to Water Cartage & Fire Fighting Pump page 61 for full pump details

## Skids

CODE	COMPATIBILITY	DIMENSIONS L x W x H
FFS600	600Ltr FTR Tanks	1595 x 1120 x 115
FFS800-1200	800 - 1200Ltr FTR Tanks	1745 x 1350 x 115
FFS2000	2000Ltr FTR Tanks	1940 x 1690 x 115



FTRS2000

# Trailer Packages

## Fire Fighting Trailers



CODE	CAPACITY (Litres)	PUMP*	STARTER	ENGINE/PUMP	TANK DIMENSIONS (L x W x H)	TRAILER DIMENSIONS (L x W x H)
FTRT1200T	1200	B65HT	Pull - Petrol	Honda/Onga	1450 x 1200 x 1000	3940 x 1770 x 1500
FTRT1200TES	1200	B65HTES	Electric - Petrol	Honda/Onga	1450 x 1200 x 1000	3940 x 1770 x 1500
FTRT1200TESD	1200	---	Electric - Diesel	Yanmar/Onga	1450 x 1200 x 1000	3940 x 1770 x 1500
FTRT2000	2000	B65HT	Pull - Petrol	Honda/Onga	1900 x 1450 x 1200	4460 x 1970 x 1650
FTRT2000ES	2000	B65HTES	Electric - Petrol	Honda/Onga	1900 x 1450 x 1200	4460 x 1970 x 1650
FTRT2000ESD	2000	FFDPTES	Electric - Diesel	Yanmar/Onga	1900 x 1450 x 1200	4460 x 1970 x 1650

### KEY FEATURES - TRAILER

- Hot dip galvanised dual axle trailer
- 14" wheels - 5 stud pattern
- Electric brakes on 2000 ltr unit
- Road pack including brakes and LED lights
- Emergency breakaway protection
- Compliance plate - road registrable

### KEY FEATURES - TANK AND PUMP

- 6.5HP Honda powered twin impeller pump
- 400mm 1/4 turn hinged lid
- Trailer mounted toolbox to protect the hose
- Suction return manifold with 6m suction hose
- 36m Hose reel & fire fighting nozzle
- Optional dust suppression nozzle kit available (DSN20K)
- \*Refer to Water Cartage & Fire Fighting Pumps page for full pump details

FTRT1200TES





# Water Cartage & Fire Fighting Pumps

CODE	DESCRIPTION	ENGINE/ PUMP	STARTER	POWER (HP)	HEAD (m)	FLOW (LPM)	INLET	OUTLET	# OF OUTLETS	WARRANTY (yrs)
MB25L	Mini Blaze 2.5HP	Loncin/Onga	Pull - Petrol	2.5	21	133	25mm BSPM	25mm BSPM	1	1
B55H	Honda 5.5HP Single Impeller	Honda/Onga	Pull - Petrol	5.5	60	585	32mm BSPM	25mm, 25mm, 40mm BSPM	3	2
B65HT	Honda 6.5HP Twin Impeller	Honda/Onga	Pull - Petrol	6.5	100	373	50mm BSPM	25mm, 25mm, 40mm BSPM	3	2
B65HTES	Honda 6.5HP Twin Impeller Electric Start	Honda/Onga	Electric - Petrol	6.5	100	373	50mm BSPM	25mm, 25mm, 40mm BSPM	3	2
FFDPTES	Yanmar 7HP Diesel Electric Start	Yanmar/Onga	Electric - Diesel	7	100	450	50mm BSPM	25mm, 25mm, 40mm BSPM	3	2

MB25L



B55H



FFDPTES

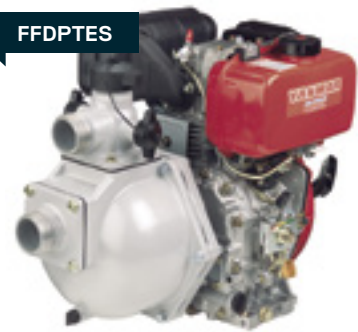

## Fire Fighting Accessories

CODE	DESCRIPTION	DIMENSIONS (L x W x H)
FFHR1	Hose Reel Only 20mm x 36mtr	555 DIA x 165W
TFFK	Tank Fire Fighting Kit with 36mtr Hose reel on galvanised stand	900 x 600 x 700
FHR	Manual Hose Reel 20mm x 36mtr	427 x 391 x 380
DSN20K	Dust Suppression Nozzle	

FFHR1



\* Does not include hose

FHR



\* Does not include hose

TFFK

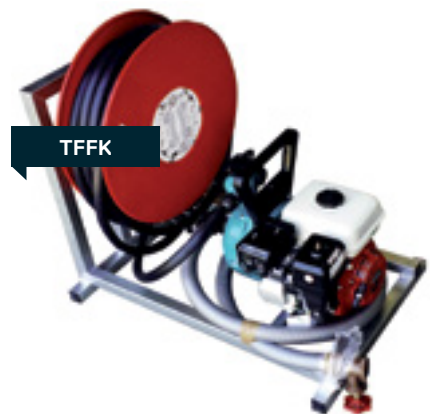

# Safety & Spill Containment

CODE	DESCRIPTION	DIMENSIONS (L x W x H)
IBCB1100	IBC Bund 1100L	1680 x 1680 x 700
LSS1	Lead safe stand	500 x 500 x 2100
FHRC36	Fire Hose Reel Cover - suits 36m hose	600 x 205 x 580
FHRC50	Fire Hose Reel Cover - suits 50m hose	575 x 270 x 600
PTC6	Drum top cover to suit 205ltr	600 x 600 x 300
BCL	Bollard Cover - Large	Ø200 x 1780H
BCS	Bollard Cover - Small	Ø120 x 1780H
BT1	Butt Tidy	Ø410 x 1000H
DSBAR	Bund-a-rack	1280 x 1280 x 280
DSDB2	Drumsafe two drum bund	1550 x 75 x 450
DSDP	Drumsafe Drumpak	Ø780 x 1080H
DSEP4	Drumsafe Econopallet 4 Drum	1210 x 1210 x 300
DSP	Drumsafe Bundled Pallet	1280 x 1280 x 335
DSST1	Splash Tray 1 Drum	830 x 830 x 100
DSST2	Splash Tray 2 Drum	1560 x 810 x 145
DSST4	Splash Tray 4 Drum	1210 x 1210 x 100



AGRICULTURE

# Order Form



T 03 5033 9000    E sales@polymaster.com.au    W polymaster.com.au

Date: _____	Site Contact name: _____
Distributor: _____	Delivery Address (if not to store): _____
Distributor ID number: _____	_____
_____	Phone: _____
Contact name: _____	Email: _____
Phone: _____	Order no. (required) _____

NO	PRODUCT CODE	DESCRIPTION	COLOUR	QTY	UNIT PRICE (EX.GST)
1					
2					
3					
4					
5					
				FREIGHT	
				TOTAL	

ADDITIONAL OPTIONS	SIZE REQUIRED	QTY	UNIT PRICE	AMOUNT
UPGRADE OUTLET?    YES <input type="checkbox"/> NO <input type="checkbox"/>				
ADDITIONAL OUTLET?    YES <input type="checkbox"/> NO <input type="checkbox"/>				
MANHOLE COVER INSTEAD OF STRAINER? <input type="checkbox"/>	MANHOLE COVER IN ADDITION TO STRAINER? <input type="checkbox"/>			
ACCESSORIES REQUIRED?    YES <input type="checkbox"/> NO <input type="checkbox"/>				

**FILL IN ADDITIONAL DETAILS BELOW FOR TANK ORDERS ONLY - SELECT FITTING POSITIONS**

Outlet: \_\_\_\_\_  
Overflow: \_\_\_\_\_

Outlet: \_\_\_\_\_  
Overflow: \_\_\_\_\_

Outlet: \_\_\_\_\_  
Overflow: \_\_\_\_\_

\* Minimum order \$300  
\* Tank specs available at [polymaster.com.au](http://polymaster.com.au)

**Email to [sales@polymaster.com.au](mailto:sales@polymaster.com.au) to place your order**

Disclaimer: Colours and sizes may vary from details printed

# Delivery & Installation

It is the owner's responsibility to provide clear access to site, and to secure tank/s left at site.

If the driver cannot reach the location, the tank/s will be left at the closest practical & safe position at the driver's discretion. If a tank can not be left at site, the owner will incur a redelivery charge.

All products can be delivered throughout Australia. Call us for a quote for deliveries outside nominated zones.

## Nominated Zones Free Delivery

Polymaster offers free delivery to site throughout most of Victoria, South Australia and parts of Southern New South Wales for tanks exceeding 13,000ltrs (remote areas excluded). Please refer to our free delivery zone map on [polymaster.com.au/delivery-installation](http://polymaster.com.au/delivery-installation).

All tanks less than 13,000ltrs are delivered free to store (within the nominated zone). A delivery fee will be incurred to deliver these tanks to site.

## Delivery Requirements

Clearance required for truck and trailer is 19m long, 5m high, 3.5m wide. To put this into perspective, our trucks are longer than a semi-trailer.

In accordance with OH&S requirements, the customer must be present at the time of delivery. If this is not possible, arrangement must be made with the distributor, friends or neighbours to ensure truck driver will have the necessary assistance as listed below.

Up to 13,500ltrs	13,500-22,500ltrs	31,700ltrs	50,000ltrs
1 person (+driver)	2 person (+driver)	3 person (+driver)	1 person (+driver)

Note:

- It is the Owners responsibility to position the tank on the pad and to connect the tank.
- Please refer to lifting instructions ([Polymaster.com.au/delivery-installation](http://Polymaster.com.au/delivery-installation)) for tanks greater than 25,000ltrs as lifting equipment will be required to position on the pad by the Owner.

Underground and Septic Tanks will require a lifting device (forklift etc) to unload from the truck. This is not supplied by the driver.

## Re-Scheduling Fee

Please be advised that if the Owner chooses to change the delivery date a re-scheduling fee will be incurred.

## Installation Guide

Entry to tank is not required when installing a Polymaster tank!

The tank site must be firm, level and flat.

A concrete pad (min dia. of tank), or well compacted sand base or other consolidated fill such as crushed dust is recommended. This fill must be free of any rocks, stones or any sharp objects.

The sand base or other consolidated fill base must be 75mm – 100mm deep and at least 600mm larger in diameter than the tank base. The outside of the base must be supported by a retaining wall to prevent erosion.

The overflow must be piped well clear of the tank to avoid any undermining of the tank base.

Ensure that a flexible hose of at least 300 mm (12") is installed after the tank valve to absorb any shocks or movement.

If tank is placed on a stand, support pipework off the stand, never support pipework off the tank.



Note: Failure to properly install tank as per instructions will void warranty. Never enter a tank alone. Have an attendant stand by. Restricted Space - only enter after carrying out a Hazard Identification Risk Assessment (H.I.R.A.).

# Index A - F

PRODUCT CODE	PAGE	PRODUCT CODE	PAGE	PRODUCT CODE	PAGE	PRODUCT CODE	PAGE
<b>A</b>		BSLT2020H5	13	DMDS2300	55	DSST2	66
A60	56	BSLT2020PC	13	DMDS3300	55	DSST4	66
A80	56	BT1	66	DMDS5000	55	DSW5000LGY	53
AFV0L	36	BUC14	49	DMDS7000	55	DSW7000LGY	53
AFV2	36	BUC26	49	DMDS10000	55	DSW10000LGY	53
AFV2L	25	BV1.5	15	DMDT	59	<b>F</b>	
AFV2LB	20/25	BV1.5A	11/14/15	DMLI	59	FCV	59
AFV2RKIT	36	BV2A	11/14/15	DMM4	59	FFDPTES	64/65
AFV2SEAL	36	BYS20	59	DMP100E	50	FFHR1	65
AFV3	36	<b>C</b>		DMP200E	50	FFS600	63
AFV3B	36	CF5L	39	DMP400E	50	FFS800-1200	63
AFV4	36	CF5P	38	DMP600	51	FFS2000	63
AFV4B	36	CF12L	39	DMP600E	50	FHR	65
AFV5	36	CF12P	38	DMP800	51	FHRC36	66
AFV5B	36	CF12P	38	DMP800E	50	FHRC50	66
AFV6	36	CF13L	39	DMP1200	51	FLBF	39
AFV6L	36	CF13P	38	DMP2000	51	FRB	35
APRS	23	CFA1	25	DMP3000	51	FSB200	43
ATN65	59	CFA2	25	DMPD600	51	FST100	43
ATN90	59	CFA2	25	DMPD800	51	FST200	43
<b>B</b>		CFAC	25	DMPD1200	51	FST300	43
B12K-P	60	CFANT	25	DMPD2000	51	FSTL30	43
B12V-COMET	60	CFS1	25	DMPD3000	51	FSTL1020	43
B12VP-P	60	CFS2	25	DMPF600	51	FT200	23
B55H	62/65	CFT8	34	DMPF800	51	FT500B	23/24
B65HT	62/63/64/65	CFT8E	34	DMPF1200	51	FT1000B	23
B65HTES	63/64/65	CLG	24/59	DMPF2000	51	FT2000B	23
B240VP-P	60	CUBE56-12V	56	DMPF3000	51	FT2000B+V	23
BATN-P	60	CUBE70-240V	56	DMPFT1200	52	FT5000B	23
BB12	46	CVB20	24	DMPFT2000	52	FT5000B+V	23
BB12L	46	<b>D</b>		DMPG400BUND	59	FT9000B	23/24
BB12XL	46	DC2	36/41/42	DMPG400E	50	FT9000B+V	23
BB16	46	DC3	29/30/31/36	DP2	32/33/36	FTL2000	23/37
BB16L	46	DC3SE	36	DP4B	36	FTP9	34/36
BB16XL	46	DCF25CLF	59	DP50K	57	FTR200	61
BBLID	46	DCF25F	59	DP50PUMP	50	FTR400	61
BC	39/42	D-CONNECT2KIT	59	DP50PUMP12V-ASY	51/57	FTR600	61
BCL	66	DCSE	36/42	DP72K	57	FTR600U	61
BCS	66	DFG200	59	DP72KA	57	FTR800	61
BDM-P	60	DFG400	59	DP72PUMP	57	FTR800U	61
BDRHP-P	60	DFG600	59	DP80K	57	FTR1200	61
BM35TNB-RES	59	DFG800	59	DP85K	57	FTR2000	61
BM100-B	60	DH2020-4M	59	DP85PUMP	52/57	FTR3000	61
BM200B-P12	60	DH2020-6M	59	DP85PUMP12V	51	FTRC200-25	62
BM400B-P12	60	DH2025-4M	59	DP1224K	57	FTRC200-55	62
BMCB-A	60	DH2025-6M	59	DP1224PUMP	57	FTRC400-25	62
BMCB-D	59	DHJ600	15/27	DP1224PUMP12V	51	FTRC400-55	62
BMHR8-P	60	DHJ800	27	DP3570K	57	FTRC600-25	62
BMLI	60	DHR10M25	59	DPK1	24	FTRC600-55	62
BMSL2000RPB	60	DM100MF	50/60	DPK1EXT	24	FTRC800-25	62
BMSL3000RPB	60	DM200MF	50/60	DPM	59	FTRC800-55	62
BMSL5000LGY-C	60	DM400MF	50/60	DPSE	36	FTRC800-55-T	62
BMSL5000RPB	60	DM600MF	50	DSBAR	66	FTRS600	63
BMTN-P	60	DM800MF	50	DSDB2	66	FTRS600ES	63
BSFMS	58	DM1200	51	DSDP	66	FTRS800	63
BSLT2020H4	13	DM2000	51	DSEP4	66	FTRS800ES	63
		DM3000	51	DSN20K	63/64/65	FTRS1200	63
		DMDMFC	59	DSP	66	FTRS1200ES	63
				DSST1	66		

# Index F - P

PRODUCT CODE	PAGE
FTRS2000	63
FTRS2000ES	63
FTRT1200T	64
FTRT1200TES	64
FTRT1200TESD	64
FTRT2000	64
FTRT2000ES	64
FTRT2000ESD	64

## G

GAB2	37
GABS	37
GBL	45
GBLLIDN	45
GRF400	37
GS40	37

## H

HB16	43
HGF13	37
HHR-370PC	26
HHR-370S-PC	14/16/26
HL4	42
HSJ1000	27
HSP	43
HT28	49
HT28P	49
HTP750VR	23

## I

IBCB1100	66
IRS32	25
IRS40	25

## J

JOS10	24
JOS65	24
JOS90	24
JOS1210	24
JWK	42

## K

K33	56
-----	----

## L

LFT50KL	22
LFT9000	22
LFT13600	22
LFT22500	22
LFT31700	22
LFTK	22
LGSO	24
LHO3SS	22/25
LHO1.5	12/16
LHO1.5SS	25
LHO1.25SS	25

PRODUCT CODE	PAGE
LHO1SS	25
LHO2	12
LHO2SS	22/25
LHO3	12
LLFC	36
LQ01	22/24
LSS1	66
LT	39/42
LT01	24
LWD	24

## M

MB25L	62/65
MB60L	46
MB60P	46
MB100L	46
MB100P	46
MB150L	46
MB150P	46
MB200L	46
MB200P	46
MBL	39
MBP	38
MCBKEYS	59
MCBKEYS-RED	59
MCBPCIF	59
MCBSW	59
MG2W	42
MG4M	40/42
MG4W	42
MG5M	40/42
MG6M	40/42
MG40P	40
MG50LTAP	40
MG50P	40
MG50TAP	40
MG60P	40
MG400T	40
MG800T	40
MGD1	42
MGD2	42
MHC1	24
MHC3	11/24
MHC4	11/24
MHC5	11/24
MHC6	11/12/24
MHC7	12
MHC8	13/14/15/16/24
MHC9	14/24
MHCA	11/12/24
MHR20-370	13/26
MHR20-550	13/26
MM1L	39
MM1P	38
MM5BR	38/39/42
MM5L	39
MM5P	38
MM8L	39
MM8P	38

PRODUCT CODE	PAGE
MM12BR	38/39/42
MM12L	39
MM12P	38
MM13L	39
MM13P	38
MM20L	39
MM20P	38
MMT400	40
MOL50KL	21
MOL13600	21
MOL22500	21
MOL31700	21
MT2	29/36
MT04	29/36
MT05	29/36
MT6	29/36
MT12	29/36
MT24	29/36
MT45	29/36
MTFC	29/36
MTN	59
MTP110	42
MTR0-2	44
MTR0-4	44
MTR1-2	44
MTR1-4	44
MTR2-2	44
MTR2-4	44
MTR2-LGEKIT	44

## O

OFF9	24
OFF10	24
OFFP	24
OS9	24

## P

PBL85	45
PBL100	45
PBL145	45
PBLD	45
PC01	15/24
PCR2000	12
PCR4000	12
PCR5000	12
PCR7000	12
PCR10000	12
PCR13500	12
PCR22500	12
PCR27000	12
PCST2000	16
PCST2000AP	16
PCST3000	16
PCST3000AP	16
PCT	38/42
PCTL12	33
PCTL24	33
PCTR22	33

PRODUCT CODE	PAGE
PCTR66	33
PCTR120	33
PH400	27
PH550	27
PHGPS	27
PLT50KL	20
PLT9000	20
PLT13600	20
PLT22500	20
PLT31700	20
PLTIP25	25
PLTIP40	25
POB20	43
PPB100	45
PPB100FC	45
PPBL	45
PSC	43
PT02	41/42
PT02FS	41/42
PT02STBR	41/42
PT03	41/42
PT03R	41/42
PT04WC	41/42
PT05	34
PT05C	34
PT05R	34
PT10W	29
PT11W	29
PT12W	29
PT13W	29
PT14	41/42
PT14BR	41/42
PT15	41/42
PT48W	41/42
PT48WB	41/42
PT49BR	41/42
PT49BRS	41
PT49W	36/41/42
PT49WB	41/42
PT50W	36/41/42
PT50WB	41/42
PT90BRS	41
PT90W	41
PT2132	25
PT2140	25
PT2150	25
PTB25	39
PTB32	39
PTBL25	39
PTBL32	39
PTC6	66
PTC36F	34
PTC36I	34
PTC37F	34
PTC37I	34
PTF18	41
PTM31F	34
PTM31W	31/36
PTM32F	34

# Index P - W

PRODUCT CODE	PAGE
PTM32W	31/36
PTM33F	34
PTM33W	31/36
PTM34F	34
PTM34W	31/36
PTMFC	31/36
PTWK6	36
PTWK7	42

## R

R10112	24
RFO1	24
RFRB	35
RFS	25
RFS2	25
RMT	40/42
RWT50KL	10/11
RWT200	10/11
RWT600	10/11
RWT1000	10/11
RWT1600	10/11
RWT2270LP	10/11
RWT2270T	10/11
RWT3300	10/11
RWT4500LP	10/11
RWT4500T	10/11
RWT5000	10/11
RWT7100	10/11
RWT9000	10/11
RWT13600	10/11
RWT22500	10/11
RWT31700	10/11

## S

S2	11/25
S3	11/12/14/25
S4	11/12/13/14/15/16/25
S5	11/12/25
SC80-F	22/25
SCIT	38/42
SCITP	42
SCL	42
SCP	42
SKD1200	51
SKD2000	51
SKD3000	51
SL5	42
SLST600	14/15
SLST1050	14/15
SLST1050AP	14
SLST1050GPS	15
SLST2000	14
SLST2000AP	14
SLST2000GPS	15
SLST3000	14/15
SLST3000AP	14
SLST3000GPS	15
SLST5000	14

PRODUCT CODE	PAGE
SLST5000AP	14
SLST5000GPS	15
SM5000D	47
SM5000HDD	47
SM5000HDL	47
SM5000L	47
SM7500D	47
SM7500HDD	47
SM7500HDL	47
SM7500L	47
SM10000D	47
SM10000HDD	47
SM10000HDL	47
SM10000L	47
SM20000L	48
SM25000L	48
SM30000L	48
SMDF5000	47
SMDF7500	47
SMDF10000	47
SPK	59
SPT5	31/36
SPT9	31/36
SPT12	31/36
SPTA	31/36
SPTAL	31/36
SSBV1	25
SSBV2	25
SSBV3	22/25
SSTS6	24
SSTS10	24
ST3100	19
ST4550	19
STB250	32
STB450	32
STBOXBASIC	56
STBOXMETER12V	56
STBOXPRO	56
STCH20	24
STCH20L	24
STLIDHGR	19
STMETER12V	56
STMETER240V	56
STRUT430MM-200N	59
SWP250	32/36
SWP250-40	32/36
SWP250FC	32/36
SWP450	32/36
SWP450-40	32/36
SWP450-50	32/36
SWP450FC	32/36
SWT15	30/36
SWT4500	30/36
SWTC	30/36

## T

TB2	24
TBC20	49
TBC20FH	49

PRODUCT CODE	PAGE
TDD1	44
TDD2	44
TDD3	44
TFFK	65
TIF3	25
TIF4	25
TR0	44
TR1	44
TR2	44
TS600	24
TS1000	24
TSPK	36
TWT60	49
TWT60S	49
TWTS	49
TWTWTAP	49

## U

UMFO	18/24
URRM	18/19/24
URT3300B	18
URT3300VF	18
URT3300VF/GP	18
URT3300VF/PC	18
URT5000B	18
URT5000VF	18
URT5000VF/GP	18
URT5000VF/PC	18
URTL	18/24
URVF01	25
URVF15	25
URVF30	25
URVFR	25
URVFWM	25

## W

WCK01	23
WCK02	23/24
WFV1	25
WFV2	25
WFV3	25



Together we hold the future.

**P:** 1800 062 064

**W:** [polymaster.com.au](http://polymaster.com.au)

Swan Hill | Melbourne | Adelaide | Sydney | Brisbane